

Taco Marine Aluminum Edge Moulding

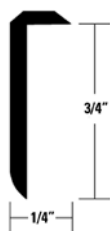

- Polished, clear anodized finish.
- Drilled and countersunk for #5 screws on 6" centers.
- Height 3/4", width 1/4".
- Length 12'.

Order No. **748270** Mfg. No. / Description (A50-0275TAL) Price **\$64.98** |

Taco Marine Aluminum T-Hatch Trim

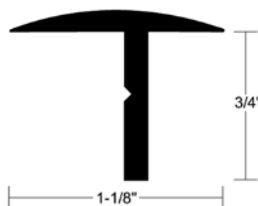

- Polished, clear anodized finish.
- Height 3/4", width 1-1/8".
- Length 12'.

Order No. **748460** Mfg. No. / Description (A50-0304TAL) Price **\$116.98** |

Taco Marine Aluminum Solid Half Oval Rub Rail



- Polished, clear anodized finish.
- Drilled and countersunk for #5 screws on 6" centers.
- Height 3/4", width 3/16".
- Length 12'.

Order No. **748129** Mfg. No. / Description (A50-0195TAL) Price **\$74.98** |

Taco Marine Aluminum Overlap Rub Rail



- Polished, clear anodized finish.
- Drilled and countersunk for #8 screws on 6" centers.
- Length 12'.

Order No. **748181** Mfg. No. / Description (A11-0151TAL) Height 3/4", Width 3/8" Price **\$72.98** |

Taco Marine Stainless Steel Hollow Back Rub Rail



- Type 304 marine grade stainless steel.
- Polished mirror finish.
- Concave back design fits rigid vinyl rub rail
- Drilled and countersunk on 6" centers.
- Length 12'.

Order No. **747709** Mfg. No. / Description (S11-4511P12) Width 3/4" .062" Gauge Screw #8 Price **\$77.98** |
 Order No. **747723** Mfg. No. / Description (S11-4650P12) Width 1" .077" Gauge Screw #10 Price **\$90.98** |

Taco Marine Rub Rail Kits



- Soft durometer rub rail provides cushion effect to absorb impact.
- Kits include: Rub rail, insert, end caps, screws and installation guide.
- Note: Refer to the illustrations on the right for correct shapes.

FLEXIBLE VINYL RUB RAIL KITS

Order No.	Mfg. No. / Description	Price
751001	(V11-0809BWK5) 1-1/16" H x 11/16" W x 50' L, Black with White Insert	\$273.98 G
751025	(V11-3447BWK5) 1-1/4" H x 15/16" W x 50' L, Black with White Insert	\$373.98 G
751013	(V11-2423BBK5) 1-7/8" H x 1-1/16" W x 50' L, Black with Black Insert	\$429.98 F
751030	(V11-3426BBK7) 1-7/8" H x 1-3/8" W x 70' L, Black with Black Insert	\$656.98 G

SEMI-RIGID VINYL RUB RAIL KITS

Order No.	Mfg. No. / Description	Price
751037	(V11-4135BKA3) 1-7/8" H x 3/4" W x 30' L, Black with No Insert	\$223.98 F
751040	(V119795BBK50) 1-1/2" H x 3/4" W x 50' L, Black with Black Insert	\$404.98 G

Taco Marine Flexible Black Vinyl Rub Rails

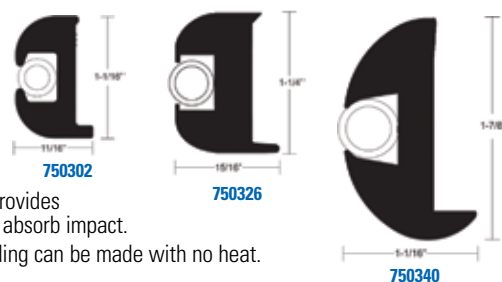

- Soft durometer provides cushion effect to absorb impact.
- Tight radius bending can be made with no heat.
- Easy to install.
- Black.

Order No.	Mfg. No. / Description	Price
750302	(V11-0809BKA) Length 50', Use Vinyl Insert V12-0810 or 3/8" Rope	\$221.98
750326	(V11-3447BKA) Length 50', Use Vinyl Insert 750542 (V12-0003) or 1/2" Rope	\$310.98
750340	(V11-2423BKA) Length 70', Use Vinyl Insert 750542 (V12-0003) or 1/2" Rope	\$665.98

Taco Marine Flexible Vinyl Inserts for Vinyl Rub Rails



- Diameter 1/2". Length 70'.

Order No.	Mfg. No. / Description	Price
750530	(V12-003WHA) Arctic White	\$141.98 LQ
750542	(V120003BKA70) Black	\$121.98

Taco Marine Nylon Rub Rail End Caps



750720



750718



- Durable black nylon.
- Caps rub rail to finish end rail.
- Ensures inserts stay intact. Screw #8.
- Sold in pairs.

Order No.	Mfg. No. / Description	Price
750718	(F90-0002BKN1) For Vinyl Rub Rail 750326	\$23.98 H
750720	(F90-0001BKN1) For Vinyl Rub Rail 750340 and V11-3426	\$37.98

- Fun & Flotation
- Anchor & Dock
- Safety
- Electronics
- Trolling Motors
- Lighting
- Electrical
- Topside Acc.
- Cockpit & Deck
- Instruments
- Steering, Controls
- Perform.
- Fuel System
- Engine & Parts
- Engine Care
- Propellers
- Seating & Pedestals
- Tops & Covers
- Pumps
- Cleaning & Care
- Paint & Paint Acc.
- Hardware, Fasteners
- Trailering
- Misc.
- Comm.

Taco Marine Aluminum Rub Rail

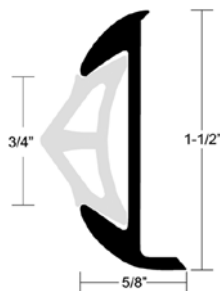

- Polished, clear anodized finish.
- Designed for use with flexible vinyl inserts.
- Drilled and countersunk for #8 screws on 6" centers.
- Length 12'.

Order No.	Mfg. No. / Description	Price
749157	(A11-0638TAL) Use Vinyl Insert 749373 (V12-0338BKA)	\$100.98

T-H Marine Rub Rail End Caps



- Molded black plastic.
- Designed to fit both aluminum and rubber rail molding.
- This unit attaches with screw through the vinyl or rope trim to prevent trim from slipping out.
- UV Stable, chemical resistant, and corrosion proof molded caps provide attractive and long lasting service.
- Sold per pair.

Order No.	Mfg. No. / Description	Price
640064	(ECR-1-DP) For 1-1/2" Molding	\$7.98 G
6400139	(ECR-2-DP) For 1-3/4" Molding	\$8.98 H

Taco Marine Flexible Vinyl Trim - Self-Locking



- Covers unfinished edges and follows almost any contour or radius.
- Made of flexible PVC.
- Integrated interior aluminum clip and gripping tongue ensures a better fit.
- Packaged 25' length per box.

Order No.	Mfg. No. / Description	Price
623635	(V301005B25-1) Black 5/32" Opening x 9/16" Flex Trim	\$83.98
623636	(V301005W25-1) White 5/32" Opening x 9/16" Flex Trim	\$83.98
623637	(V301008B25-1) Black 1/4" Opening x 1/2" Flex Trim	\$83.98
623638	(V301008W25-1) White 1/4" Opening x 1/2" Flex Trim	\$83.98
623639	(V301312B25-1) Black 3/8" Opening x 5/8" Flex Trim	\$96.98

Taco Marine Flexible Black Vinyl Inserts for Aluminum Rub Rail



- Designed for use with aluminum rub rails.
- Length 50'.

Order No.	Mfg. No. / Description	Price
749311	(V12-0317BKA) For Aluminum Rub Rail A11-0317	\$83.98
749373	(V12-0338BKA) For Aluminum Rub Rail 749157 (A11-0638)	\$135.98 LQ
749400	(V12-0342BKA) For Aluminum Rub Rail A11-0342	\$97.98

T-H Marine Rub Rail Splice



- Molded black plastic.
- Design to fit both aluminum and rubber rail molding.
- UV Stable, chemical resistant, and corrosion proof molded caps provide attractive and long lasting service.
- Butt splice for 1-1/4" to 1-1/2" rub rail, 2-1/4" long.

Order No.	Mfg. No. / Description	Price
6400278	(SR-1-DP)	\$5.98 H

Standard Products Vinyl Trim - Self-Locking

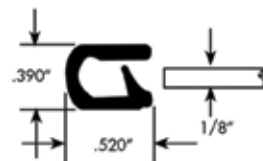

- Flexible embossed vinyl aluminum core QuickEdge trim.
- Standard single lip trim for 1/8" to 3/16" edges.
- Grips edges from .090" to .190" thick.
- Priced per foot. Sold 200' rolls only. One box = Two rolls (400').

Order No.	Mfg. No. / Description	Price
623643	(75000346) White	\$3.37/ft.
623644	(75000348) Black	\$3.48/ft.

- Fun & Flotation
- Anchor & Dock
- Safety
- Electronics
- Trolling Motors
- Lighting
- Electrical
- Topside Acc.
- Cockpit & Deck
- Instruments
- Steering, Controls
- Perform.
- Fuel System
- Engine & Parts
- Engine Care
- Propellers
- Seating & Pedestals
- Tops & Covers
- Pumps
- Cleaning & Care
- Paint & Paint Acc.
- Hardware, Fasteners
- Trailering
- Misc.
- Comm.

Perko Figs. 918 Latch and Lock Set



- Chrome plated zinc alloy.
- Regular bevel with box strike.
- Locks by turn button from inside or key from outside.
- For door thickness: 5/8" to 1-3/8".
- Dimensions case: 3-7/8" x 2".
- Dimensions escutcheon: 4-3/8" x 1-1/4".
- Uses #6 fasteners.
- Complete with two keys.

Order No.	Mfg. No. / Description	Price
543517	(0918 DPO CHR)	\$175.98 R

Perko Fig. 567 Tubular Latch Set



- Chrome plated zinc alloy.
- Sliding lock button.
- For door thickness 1" to 1-3/8".
- Dimensions case: 4-3/8" x 1-1/4".
- Tube OD 3/4".
- Uses #6 fasteners.

Order No.	Mfg. No. / Description	Price
540977	(0567 DPO CHR)	\$114.98 R

Perko Fig. 960 Mortise Latch Set



- Chrome plated zinc alloy.
- Turn button lock.
- Bevel can be reversed during installation.
- For doors thickness: 1" to 1-3/8".
- Dimensions case: 2-1/4" x 1-13/16".
- Dimensions escutcheon: 4-3/8" x 1-1/4".
- Uses #6 fasteners.

Order No.	Mfg. No. / Description	Price
543973	(0960 DPO CHR)	\$102.98 R

T-H Marine Recessed Lock and Recessed Latches



- For aluminum, fiberglass and composite lids.
- Watertight O-ring seal.
- Molded from tuff engineering grade black nylon.
- Stainless steel lift ring.
- Rotates 360° right or left.
- Fits 2-3/8" to 2-1/2" hole.

Order No.	Mfg. No. / Description	Price
639849	(RL-1-DP) Locking	\$34.98 H
641084	(NRL-1-DP) Latch, Non-Locking	\$30.98 H

Perko Figs. 928 and 930 Rim Latch Sets

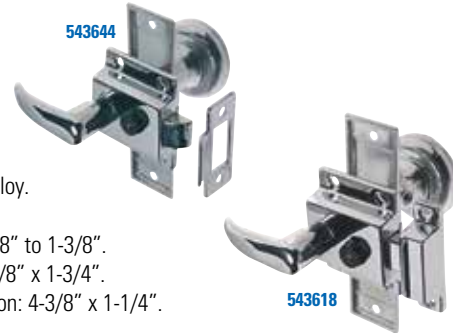

- Chrome plated zinc alloy.
- Sliding lock button.
- For door thickness: 5/8" to 1-3/8".
- Dimensions case: 2-1/8" x 1-3/4".
- Dimensions escutcheon: 4-3/8" x 1-1/4".
- Uses #6 fasteners.

Order No.	Mfg. No. / Description	Price
543618	(0928 DPO CHR) Regular Bevel with Box Strike	\$99.98 R
543644	(0930 DPO CHR) Regular Bevel with Flush Strike	\$99.98 R

Perko Fig. 927 Mortise Lock Set



- Chrome plated zinc alloy.
- Locked by turn button from inside or key from outside.
- Bevel can be reversed during installation.
- For door thickness: 1" to 1-3/8".
- Dimensions case: 2-3/4" x 2".
- Dimensions escutcheon: 4-3/8" x 1-1/4".
- Uses #6 fasteners.
- Complete with two keys.

Order No.	Mfg. No. / Description	Price
543606	(0927 DPO CHR)	\$157.98 R

Perko Figs. 931 and 932 Flush Lock and Latches



- Chrome plated zinc alloy.
- Black polymer with stainless steel stem and lock nut.
- For door thickness 1/4" to 1-1/8".
- Installs in a 2" diameter hole.
- Face plate dimensions: 2-1/2" x 2-1/2".
- Adjustment cam bar: 3/8" to 3".

WITH OFFSET CAM BAR AND FLEXIBLE POLYMER STRIKE

Order No.	Mfg. No. / Description	Price
543632	(0932 DP1 BLK) Latch, Non-Locking	\$42.98 R
543648	(0931 DP1 BLK) Lock with 2 Keys	\$48.98 R

WITH OFFSET ADJUSTABLE CAM BAR

Order No.	Mfg. No. / Description	Price
543640	(0932 DP2 BLK) Latch, Non-Locking	\$42.98 R
5315155	(931DP2BLK) Lock with 2 Keys	\$49.98 H

REPLACEMENT OFFSET CAM BAR

Order No.	Mfg. No. / Description	Price
543649	(0931 001 99A)	\$18.98 Q

- Fun & Flotation
- Anchor & Dock
- Safety
- Electronics
- Trolling Motors
- Lighting
- Electrical
- Topside Acc.
- Cockpit & Deck**
- Instruments
- Steering, Controls
- Perform.
- Fuel System
- Engine & Parts
- Engine Care
- Propellers
- Seating & Pedestals
- Tops & Covers
- Pumps
- Cleaning & Care
- Paint & Paint Acc.
- Hardware, Fasteners
- Trailering
- Misc.
- Comm.

Perko Fig. 921 Flush Lock and Latch



- Chrome plated zinc alloy.
- Lock with 2 keys.
- For door thickness 1/2" to 3/4".
- Installs in a 1-5/8" diameter hole.
- Face plate dimensions: 2-1/4" x 2".

Order No.	Mfg. No. / Description	Price
543531	(0921 DP0 CHR)	\$55.98 R

White Cap T-Handle Latches



- Black nylon.
- Diameter 3".
- Cut-out: 2-1/2".
- Surface depth: 1/8" - 3/4".
- Includes: Neoprene O-ring, key and fastener.
- Note: Must order cam bar separately!

WITH CHROME PLATED ZAMAC T-HANDLE

Order No.	Mfg. No. / Description	Price
2011596	(S-226B) Locking No Cam Bar	\$29.95 H

WITH BLACK NYLON T-HANDLE

Order No.	Mfg. No. / Description	Price
2011610	(S-3226B) Locking No Cam Bar	\$28.95 H
2011611	(S-3230B) Non-Locking No Cam Bar	\$19.95 H

T-HANDLE CAM BARS

- Zinc cam bar.
- Cam ONLY!
- Order T-handle latches separately.

Order No.	Mfg. No. / Description	Price
2011597	(S-2260L) Offset Long, Diameter 2-7/8"	\$4.95 H
2011598	(S-2260LS) Offset Long Star with Opening, Dia. 2-7/8"	\$4.95 G
2011600	(S-226SL) Straight Long, Diameter 2-5/8"	\$4.95 H
2011601	(S-0226ASTR) Straight Long Star with Opening, Dia. 2-5/8"	\$4.95 H

T-H Marine Nautical Slam Latch



- Oval top, nautical design.
- Low profile.
- Totally corrosion resistant.
- UV stable.
- Simple installation in a 2" round hole.
- Fits 1-1/16" to 7/8" lids.
- Resistant to chemicals including acetone, alcohol, gasoline, etc.
- Stainless steel pawl catch and mounting hardware.

Order No.	Mfg. No. / Description	Price
641085	(NFSL-5-1-DP) Black	\$20.98 H

Perko Fig. 1091 Surface Mount Locks and Latches



- Black polymer body.
- Chrome plated zinc alloy "T" handle.
- For smooth and carpeted surfaces.
- Stainless steel stem.
- Lock with 2 keys.
- Face plate diameter: 3".
- Installs in a 2-1/2" diameter hole for mounting surfaces 1/8" to 3/4" thick.

Order No.	Mfg. No. / Description	Price
536520	(1091 DP1 BLK) Offset Cam Bar Adjusts 3/4" to 2-3/8"	\$52.98 R
5315033	(1091DP3BLK) Straight Cam Bar Adjusts 1-1/4" to 1-7/8"	\$50.98 H

Perko Fig. 1092 Surface Mount Locks and Latches



- Black polymer body.
- Chrome plated zinc alloy "T" handle.
- For smooth and carpeted surfaces.
- Stainless steel stem.
- Latch (non-locking).
- Diameter adjustment: 3".
- Installs in a 2-1/2" diameter hole for mounting surfaces 1/8" to 3/4" thick.

Order No.	Mfg. No. / Description	Price
5315035	(1092DP1BLK) Offset Cam Bar Adjusts 3/4" to 2-3/8"	\$46.98 H
5315036	(1092DP3BLK) Straight Cam Bar Adjusts 1-1/4" to 1-7/8"	\$46.98 H

T-H Marine Anchor Handle Locks



- Sure grip two-finger handle.
- Fits aluminum, fiberglass and carpeted lids.
- Waterproof O-ring seal.
- Stainless steel stem.
- Gasket included for smooth surface applications.
- Powder coated steel pawls-straight and offset.
- Toothed and Double-D shaped mounting for carpeted lids.
- Single hex nut installation.
- Mounts in lids up to 3/4" thick.
- Installs into a 2-3/8" to 2-1/2" hole.
- Universal replacement for all T-H Marine or Perko.

Order No.	Mfg. No. / Description	Price
639802	(ALC-2-DP) White Base with Chrome Handle	\$35.98 H
639804	(ALC-1-DP) Black Base with Chrome Handle	\$35.98 H
639806	(AL-1-DP) Black Base with Black Handle	\$32.98 H

Marpac Push to Close Latches



Non-Locking Latch

Locking Latch

- Flush mount - pull to open.
- Single, round-hole installation.
- Inside actuation when locked or unlocked.
- Stainless steel face/pull, with corrosion resistant materials in body.

NON-LOCKING LATCHES

Order No.	Description	Price
7-2267	1-3/4" OD 1-3/8" Cut Out	\$23.98 G
7-2270	2-3/8" OD 2" Cut Out	\$29.98 G

LOCKING LATCHES

Order No.	Description	Price
7-2268	1-3/4" OD 1-3/8" Cut Out	\$31.98 G
7-2271	2-3/8" OD 2" Cut Out	\$34.98 G

T-H Marine Anti-Rattle Pontoon Gate Door Stops



- Injection molded pontoon gate door stop.
- Designed to fit 1-1/4" square tubing.
- Stops gate rattle. Requires no welding.
- Simple installation with one #10 screw.
- Ribs to align on post.
- Gray.

Order No.	Mfg. No. / Description	Price
6400127	(DS-1L-DP) With Ribs for 1-1/4" Tubing Left Hinge	\$5.98 H
6400128	(DS-1R-DP) With Ribs for 1-1/4" Tubing Right Hinge	\$5.98 H
6400129	(DS-2L) Without Ribs, Universal Fit Left Hinge	\$3.87 H
6400130	(DS-2R) Without Ribs, Universal Fit Right Hinge	\$3.87 H

Perko Fig. 1216 Door Button with Spring



- Chrome plated zinc alloy.
- Black polymer button.
- Supplied with phosphor bronze tension spring.
- 1-3/4" OD.
- Uses #6 fasteners.

Order No.	Mfg. No. / Description	Price
533364	(1216 DPO CHR)	\$14.98 R

T-H Marine Earth Magnetic Latch



- Powerful magnetic attraction.
- Holds lids and doors securely.
- Encased in plastic - won't rust or corrode.

Order No.	Mfg. No. / Description	Price
642270	(MAGHL-2-DP)	\$31.98 H

Marpac Lift Handles



- Cast stainless steel.
- Latches/non-locking hatch.

Order No.	Description	Price
7-1370	3"	\$59.98 G
7-1371	2-1/2"	\$39.98 G

Marpac Push to Close Latch



- Black plastic.
- Flush pull - pull to open.
- Corrosion resistant materials.
- Single, round-hole installation.

Order No.	Description	Price
7-2265	2"	\$24.98 G

Perko Fig. 1177 Door Stop



- Chrome plated zinc alloy. Rubber bumper.
- Length 1". 1-1/4" OD.
- Uses #4 fasteners.

Order No.	Mfg. No. / Description	Price
532906	(1177 DPO CHR)	\$10.98 R

Perko Fig. 574 Door Stop and Holder



- Chrome plated bronze.
- Rubber bumper.
- Dimensions: 3-1/4" L x 1-3/4" O.D.

Order No.	Mfg. No. / Description	Price
534068	(0574 DP2 CHR)	\$120.98 R

Phoenix Lock Door Stop and Holder



- Cast solid brass with white rubber cushion.
- Base diameter 1-3/4".
- Projection 3-3/4".

Order No.	Mfg. No. / Description	Price
546967	(150-W) White Rubber Cushion	\$3.75 LQ

Perko Fig. 1056 Elbow Catch



- Chrome plated zinc alloy with stainless steel spring.
- Dimensions: 1-1/8" x 9/16".
- Uses #6 fasteners.

Order No.	Mfg. No. / Description	Price
531675	(1056 DPO CHR)	\$17.98 R

- Fun & Flotation
- Anchor & Dock
- Safety
- Electronics
- Trolling Motors
- Lighting
- Electrical
- Topside Acc.
- Cockpit & Deck
- Instruments
- Steering, Controls
- Perform.
- Fuel System
- Engine & Parts
- Engine Care
- Propellers
- Seating & Pedestals
- Tops & Covers
- Pumps
- Cleaning & Care
- Paint & Paint Acc.
- Hardware, Fasteners
- Trailering
- Misc.
- Comm.

Marpac Ball Catch



- Type 316 cast stainless steel.
- Heavy duty.
- Dimensions: 2" x 3/8".

Order No.	Description	Price
7-0221	Ball Catch	\$10.98 G

Marpac Plastic Door Latch



- Set includes one male and one female.
- Uses #6 fasteners.
- Sold 3 sets per card.

Order No.	Description	Price
7-0220	Plastic Door Latch	\$9.98 G

Perko Fig. 554 Door Catch



- White polymer.
- Stainless steel mounting and keeper screws.
- Catch dimensions: 1-1/4" x 5/8".
- Catch screw size 3/4" x #8.
- Uses #4 R.H. fasteners.
- Sold 2 per pack.

Order No.	Mfg. No. / Description	Price
540837	(0554 DP)	\$12.98 R

Perko Fig. 559 Door Catch



- Black polymer ball stud and socket.
- Stud dimensions: 1-1/8" x 3/8".
- Socket dimensions: 1-3/8" x 7/8".
- Uses #4 R.H. fasteners.
- Sold 2 per pack.

Order No.	Mfg. No. / Description	Price
540838	(0559 DP)	\$7.98 R

Perko Fig. 1065 Door Holder



- Stainless steel clip has 1-3/8" x 7/16" base.
- Chrome plated zinc alloy arrow has 1-5/8" x 3/4" base.
- Projects 1-3/4".
- Uses #8 fasteners.

Order No.	Mfg. No. / Description	Price
531764	(1065 DP0 CHR)	\$27.98 R

Phoenix Lock Cabin Door Hook



- Cast solid polished brass.
- Length 6".
- Users #8 fasteners.



Order No.	Mfg. No. / Description	Price
547426	(220-6-P)	\$36.98 LQ

Perko Fig. 1199 Cabin Door Hooks



- Chrome plated zinc alloy.
- Lightweight design.
- Uses #6 fasteners.

Order No.	Mfg. No.	Hook Length	Price
533263	(1199 DP1 CHR)	1-3/4"	\$13.98 R
533249	(1199 DP2 CHR)	2-1/4"	\$13.98 R
533251	(1199 DP3 CHR)	3"	\$14.98 R

Perko Fig. 1287 Cabin Door Hooks



- Chrome plated zinc alloy.
- Modern design.
- Uses #6 fasteners.

Order No.	Mfg. No.	Hook Length	Price
534037	(1287 DP1 CHR)	2"	\$12.98 R
534051	(1287 DP2 CHR)	2-1/2"	\$13.98 R
534063	(1287 DP3 CHR)	3"	\$13.98 R

Perko Fig. 956 Cabin Door Hooks



- Chrome plated cast bronze.
- Sold 1 piece per card, 5 cards per box

Order No.	Mfg. No.	Hook Length	Price
547337	(0956DP4CHR)	3"	\$34.98 R
547349	(0956DP6CHR)	4"	\$49.98 R
547363	(0956DP8CHR)	6"	\$60.98 R

Perko Fig. 1102 Cupboard Catches



- Chrome plated zinc alloy.
- Overall dimensions: 1-1/2" x 1-7/8".
- Uses #6 fasteners.

Order No.	Mfg. No. / Description	Price
531942	(1102 001 CHR) Box Strike	\$34.98 H
531954	(1102 002 CHR) 3/8" Box Strike	\$34.98 H
531957	3/16" Spacers for 531954	\$4.22 F

Perko Fig. 1101 Cupboard Bolt



- Chrome plated zinc alloy.
- Black polymer slide and knob.
- Overall dimensions: 2-1/8" x 1-1/2".
- Uses #6 fasteners.

Order No.	Mfg. No. / Description	Price
531928	(1101 DP0 CHR)	\$27.98 R

Perko Fig. 1053 Ship Bolt



- Chrome plated bronze.
- Includes brass friction spring to eliminate rattle and provide detented operation.
- Overall dimensions: 2-5/8" x 1-1/4".
- Uses #6 fasteners.

Order No.	Mfg. No. / Description	Price
531649	(1053 DP0 CHR)	\$56.98 R

- Fun & Flotation
- Anchor & Dock
- Safety
- Electronics
- Trolling Motors
- Lighting
- Electrical
- Topside Acc.
- Cockpit & Deck
- Instruments
- Steering, Controls
- Perform.
- Fuel System
- Engine & Parts
- Engine Care
- Propellers
- Seating & Pedestals
- Tops & Covers
- Pumps
- Cleaning & Care
- Paint & Paint Acc.
- Hardware, Fasteners
- Trailer
- Misc.
- Comm.

Perko Fig. 947 Barrel Bolts



- Chrome plated bronze body and high impact black nylon bulkhead keeper.
- 3/8" Diameter bolt.
- Bulkhead keeper easily installs in a 5/8" hole.
- Includes friction pad to eliminate rattle and provide smooth operation.
- Includes both styles of keepers.
- Uses #6 fasteners.

Order No.	Mfg. No. / Description	Price
547298	(0947DP1CHR) Overall Dimensions: 3-7/16" x 1-7/16"	\$53.98 R
543808	(0947 DP2 CHR) Overall Dimensions: 4-5/16" x 1-7/16"	\$49.98 R
543535	(0947 DP3 CHR) Overall Dimensions: 5-1/4" x 1-7/16"	\$60.98 R

Marpac Barrel Bolts



- Precision cast stainless steel.

Order No.	Description	Price
7-0409	Dimensions: 3-1/2" x 1-1/2"	\$19.98 G
7-0410	Dimensions: 4-1/2" x 1-1/2"	\$19.98 G

Perko Fig. 1051 Flush Ring Catch



- Chrome plated zinc alloy.
- Phosphor bronze spring.
- Dimensions: 2-1/4" x 1-3/8".
- Uses #6 fasteners.

Order No.	Mfg. No. / Description	Price
531637	(1051 DPO CHR)	\$28.98 R

Boater Sports Locking Lift Ring



- Keep valuables protected with this easy to install lock.
- Includes regular and offset cams.
- 2 Keys.
- 2-1/8" x 1-15/16".

Order No.	Mfg. No. / Description	Price
1-54205	(54205)	\$10.49 H

Marpac Lift Ring



- Polished, stamped type 304 stainless steel.
- Surface mount.
- Dimensions: 2-1/8" x 1-15/16".

Order No.	Description	Price
7-0084	Lift Ring	\$6.98 G

Marpac Flush Lifting Handle



- Stainless steel, recessed.
- Dimensions: 2-1/4" x 3".
- Uses #8 fasteners.

Order No.	Description	Price
7-0085	Flush Lifting Handle	\$7.98 G

Boater Sports Hatch Lift Handle



- Marine grade stainless steel.
- Mount with four #8 screws (Not included).
- Measures 3" W x 2-1/4" L.

Order No.	Mfg. No. / Description	Price
1-54206	(54206)	\$6.95 H

White Cap Large Lift Ring



- Chrome plated brass.
- Provides strength for lifting large and heavy hatch covers.
- Overall dimensions: 3" x 2".
- Handle size: 2" L x 3/4" I.D. lift ring.
- Installs with four #8 screws.

Order No.	Mfg. No. / Description	Price
2011620	(S-3364C)	\$11.95 H

Perko Fig. 1220 Flush Lifting Handle



- Chrome plated zinc alloy.
- Face plate dimensions: 3" x 2-1/4".
- Inside handle dimensions: 1-7/8" x 1".
- Uses #8 fasteners.

Order No.	Mfg. No. / Description	Price
533427	(1220 DPO CHR)	\$21.98 R

Perko Fig. 776 Flush Lifting Handle



- Chrome plated bronze.
- Face plate dimensions: 3" x 2-1/4".
- Inside handle dimensions: 1-7/8" x 1".
- Uses #8 fasteners.

Order No.	Mfg. No. / Description	Price
542185	(0776 DP1 CHR)	\$70.98 R

Perko Fig. 776 Flush Lifting Handle



- Chrome plated bronze.
- Has all mounting holes at corners.
- Face plate dimensions: 3-3/4" x 2-3/4".
- Inside handle dimensions: 2-3/16" x 1-3/16".
- Uses #8 fasteners.

Order No.	Mfg. No. / Description	Price
542197	(0776 DP2 CHR)	\$84.98 R

- Fun & Flotation
- Anchor & Dock
- Safety
- Electronics
- Trolling Motors
- Lighting
- Electrical
- Topside Acc.
- Cockpit & Deck
- Instruments
- Steering, Controls
- Perform.
- Fuel System
- Engine & Parts
- Engine Care
- Propellers
- Seating & Pedestals
- Tops & Covers
- Pumps
- Cleaning & Care
- Paint & Paint Acc.
- Hardware, Fasteners
- Trailering
- Misc.
- Comm.

- Fun & Flotation
- Anchor & Dock
- Safety
- Electronics
- Trolling Motors
- Lighting
- Electrical
- Topside Acc.
- Cockpit & Deck
- Instruments
- Steering, Controls
- Perform.
- Fuel System
- Engine & Parts
- Engine Care
- Propellers
- Seating & Pedestals
- Tops & Covers
- Pumps
- Cleaning & Care
- Paint & Paint Acc.
- Hardware, Fasteners
- Trailing
- Misc.
- Comm.

White Cap Flush Pull Ring



- These flush rings are all chrome plated.
- Maintains a flush appearance and recessed for safety.
- Dimensions: 2" x 2-1/2".

Order No.	Mfg. No. / Description	Price
2011619	(S-3362C)	\$9.95 H

Perko Fig. 1103 Flush Ring Pull



- Chrome plated bronze.
- Face plate dimensions: 2-9/16" x 2".
- Uses #8 fasteners.

Order No.	Mfg. No. / Description	Price
531978	(1103DPOCHR)	\$48.98 R

Perko Fig. 575 Flush Ring Pull



- Chrome plated bronze.
- Face plate dimensions: 2-5/8" x 2".
- Uses #8 fasteners.

Order No.	Mfg. No. / Description	Price
541044	(0575 DPO CHR)	\$49.98 R

Perko Fig. 841 Flush Ring Pull



- Chrome plated zinc alloy.
- Face plate dimensions: 1-3/4" x 1-3/8".
- Uses #6 fasteners.

Order No.	Mfg. No. / Description	Price
542490	(0841 DPO CHR)	\$16.98 R

Perko Fig. 1232 Flush Ring Pull



- Chrome plated zinc alloy.
- Face plate 1-5/8" OD.
- Uses #6 fasteners.

Order No.	Mfg. No. / Description	Price
533618	(1232 DP1 CHR)	\$16.98 R

Boater Sports Flush Hatch Pull



- Injection molded and large enough to get your fingers in.
- Strong material will flex but not break when stepped on.
- Dimensions: 2-1/4" x 2-1/4".

Order No.	Mfg. No. / Description	Price
1-54207	(54207)	\$2.95 H

T-H Marine Lid Lift Pulls



- Injection molded and large enough to get your fingers in.
- The bottom cup prevents water from entering box.
- Strong material will flex but will not break when stepped on.
- Mount with four #6 screws.
- Large lid lifts have a 2-3/4" square top and require a 2-1/8" diameter hole for mounting.
- Small lid lifts have a 2-1/4" square top and require a 1-3/4" diameter hole for mounting.

Order No.	Mfg. No. / Description	Price
642277	(LL-1-DP) Large Lid Lift Black	\$4.30 H
6400217	(LLM-1-DP) Small Lid Lift Black	\$3.90 H

Perko Fig. 1016 Flush Pull



- Black polymer.
- Easily installs in a 1-3/4" diameter hole.
- Face plate dimensions: 2-1/4" x 2-1/4".
- Depth 15/16".
- Uses #6 fasteners.

Order No.	Mfg. No. / Description	Price
531550	(1016 DPO BLK)	\$4.42 H

Marpac Hatch Cover Pull



- Type 304 stainless steel with attractive electro-polished finish.
- Stainless steel washer and keep ring.
- Lays flat - easy to use.
- Lifting disc: 1-1/4".
- Stem diameter: 3/16".

Order No.	Description	Price
7-0651	Hatch Cover Pull	\$4.98 G

Marpac Drawer Knob



- Cast 316 stainless steel with 1" screw.
- Diameter 1"

Order No.	Description	Price
7-0408	Drawer Knob	\$6.98 G

Perko Fig. 958 Drawer Pull



- Chrome plated zinc alloy.
- Overall width 3-7/16", inside width 2-5/16".
- Uses #6 fasteners.

Order No.	Mfg. No. / Description	Price
543961	(0958 DPO CHR)	\$16.98 R

Marpac Push to Close Latch



- Chrome.
- Corrosion and UV resistant.
- Quick, round-hole installation.
- Pull the knob to open, simply push the door to close.
- Knob stores flush; pops out at a touch.

Order No.	Description	Price
7-2285	Push to Close Latch	\$29.98 G

Marpac Push to Close Latch



- Glass reinforced black nylon.
- Corrosion resistant.
- Locking. Push-button style.
- Pull tab in line with latching pawl.

Order No.	Description	Price
7-2280	Push to Close Latch	\$26.98 G

Marpac Swivel Lock Hasps



- Type 304 stamped stainless steel.
- A strong versatile utility hasp with a swivel head.
- Uses #6 fasteners.

Order No.	Description	Price
7-0216	Dimensions: 2-3/4" x 1"	\$9.98 G
7-0218	Dimensions: 3-1/4" x 1"	\$13.98 G

Perko Fig. 1198 Safety Hasps



- Chrome plated zinc alloy.
- Width 1".
- Padlock clearance 1/4".
- Uses #6 fasteners.

Order No.	Mfg. No. / Description	Price
533237	(1198 DP2 CHR) Closed 3" L	\$22.98 R
533227	(1198 DP3 CHR) Closed 3-3/4" L	\$22.98 R

Perko Fig. 998 Safety Hasp



- Chrome plated bronze.
- Width 1".
- Closed length 3".
- Padlock clearance 9/32".
- Uses #6 fasteners.

Order No.	Mfg. No. / Description	Price
544329	(0998 DP2 CHR)	\$52.98 R

Perko Fig. 1194 Swivel Safety Lock Hasp



- Chrome plated zinc alloy.
- Padlock eye swivels to act as a latch.
- Width 1". Closed length 3".
- Padlock clearance 11/32".
- Uses #6 fasteners.

Order No.	Mfg. No. / Description	Price
533173	(1194 DPO CHR)	\$25.98 R

SPARE KEEPER, 1 PER CARD

Order No.	Mfg. No. / Description	Price
533174	(1194 DPO 99A)	\$13.98 R

Marpac 90° Angle Bracket



- Polished stainless steel.
- Leg length 2-3/8", leg width 9/16".
- Sold per pair.

Order No.	Description	Price
7-0411	90° Angle Bracket	\$5.98 G

Marpac Butt Hinges



- Polished, stamped type 304 stainless steel.
- .060 gauge.
- Sold per pair.

Order No.	Description	Price
7-1007	Open Width 2" Pin Length 2" Uses #8 Fasteners	\$10.98 G
7-1008	Open Width 2" Pin Length 3" Uses #8 Fasteners	\$39.98 G
7-1009	Open Width 3" Pin Length 3" Uses #10 Fasteners	\$14.98 G

Marpac Stay-Put Hinges



- 316 stainless steel and phosphor bronze construction for maximum corrosion resistance.
- No more limp hinges.
- Holds open hatches, live well lids, electronic box doors-stays where it's put.
- Eliminates the need for gas shocks or hatch springs in some applications.
- Patented friction technology from GEM.
- Replaces existing hinges with matching mounting holes.
- Used on over 100 boat manufacturers including: Chaparral Boats, Robalo Boats, Yellowfin Yachts, Sea Ray, Sea Hunt Boats, Tidewater Boats, Sundance Skiffs, Maverick, Cobia and Key West Boats.
- Uses #8 fasteners.
- Note: DO NOT attempt to adjust the tension of the friction hinge in any way.

Order No.	Description	Price
7-1475	Butt Hinge 4 Hole 1-1/2" L x 1-1/2" W	\$31.98 G
7-1479	Utility Hinge 6 Hole 3" L x 1-1/2" W	\$36.98 G
7-1481	Butt Hinge 4 Hole 2" L x 2" W	\$36.98 G
7-1483	Butt Hinge 6 Hole 3" L x 2" W	\$44.98 G

- Fun & Flotation
- Anchor & Dock
- Safety
- Electronics
- Trolling Motors
- Lighting
- Electrical
- Topside Acc.
- Cockpit & Deck
- Instruments
- Steering, Controls
- Perform.
- Fuel System
- Engine & Parts
- Engine Care
- Propellers
- Seating & Pedestals
- Tops & Covers
- Pumps
- Cleaning & Care
- Paint & Paint Acc.
- Hardware, Fasteners
- Trailering
- Misc.
- Comm.

- Fun & Flotation
- Anchor & Dock
- Safety
- Electronics
- Trolling Motors
- Lighting
- Electrical
- Topside Acc.
- Cockpit & Deck
- Instruments
- Steering, Controls
- Perform.
- Fuel System
- Engine & Parts
- Engine Care
- Propellers
- Seating & Pedestals
- Tops & Covers
- Pumps
- Cleaning & Care
- Paint & Paint Acc.
- Hardware, Fasteners
- Trailing
- Misc.
- Comm.

Marpac Butt Hinges



STAINLESS STEEL

- Uses #8 fasteners.
- Sold per pair.

Order No.	Description	Price
7-0686	1-5/16" W (Open) x 1-1/2" L	\$8.98 G

HEAVY DUTY, CAST STAINLESS STEEL

- Uses #10 fasteners.
- Sold per pair.

Order No.	Description	Price
7-0970	1-1/2" x 1-1/2"	\$20.98 G

Guden Tight Pin Butt Hinge

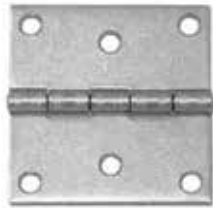

- Square type 304 stainless steel.
- Pin spun on both ends.
- Standard hole pattern and countersunk holes.
- Both halves half swagged for tight closure.
- Sold per pair.

Order No.	Description	Price
377475	3" x 3" .078" Gauge 6 Screws Per Hinge	\$35.98 Q

Marpac Utility Hinge



- Stamped stainless steel.
- Open width 3".
- Pin length 1-1/2".
- Uses #8 fasteners.
- Sold per pair.

Order No.	Description	Price
7-0457	Utility Hinge	\$10.98 G

Perko Fig. 924 Hinge



- Chrome plated stamped brass.
- Open width 3", pin height 1-1/2".
- Uses #6 fasteners.
- Sold per pair.

Order No.	Mfg. No. / Description	Price
543581	(0924 DPO CHR)	\$32.98 R

Marpac Utility Hinge



- Stamped stainless steel.
- Flush mount.
- Dimensions: 2.664" x 1.5".
- Sold per pair.

Order No.	Description	Price
7-1010	Utility Hinge	\$16.98 G

Marpac Utility Hinge



- Stamped stainless steel.
- Open width 2".
- Pin length 1-1/2".
- Uses #8 fasteners.
- Sold per pair.

Order No.	Description	Price
7-0458	Utility Hinge	\$9.98 G

Perko Fig. 1293 Loose Pin Butt Hinges



- Chrome plated zinc alloy.
- Stainless steel removable pin.
- Uses #8 fasteners, except 534176 uses #10 fasteners.
- Sold per pair.

Order No.	Mfg. No. / Description	Price
534138	(1293 DP3 CHR) 1-1/2" x 2" 4 Screws Per Hinge	\$25.98 R
534188	(1293 DP4 CHR) 2" x 2" 4 Screws Per Hinge	\$26.98 R
534176	(1293 DP9 CHR) 3" x 3" 6 Screws Per Hinge	\$33.98 R

White Cap Butt Hinge



- Stamped 304 stainless steel.
- Uses #8 fasteners.
- Sold per pair.

Order No.	Mfg. No. / Description	Price
2011623	(S-3421C) 3" H x 3" W	\$18.95 H

Perko Fig. 951 Hinge



- Chrome plated bronze.
- Open width 3", pin height 1-1/2".
- Uses #8 fasteners.
- Sold per pair.

Order No.	Mfg. No. / Description	Price
543858	(0951 DP1 CHR)	\$80.98 R

Perko Fig. 808 Hinge



- Chrome plated zinc alloy.
- Open width 3", pin height 1-1/2".
- Uses #8 fasteners.
- Sold per pair.

Order No.	Mfg. No. / Description	Price
542325	(0808 DPO CHR)	\$31.98 R

Perko Fig. 1213 Shortside Hinge



- Chrome plated zinc alloy.
- Open width 2-1/2", shortside width 3/4".
- Pin height 1-1/2".
- Uses #8 fasteners.
- Sold per pair.

Order No.	Mfg. No. / Description	Price
533338	(1213 DP1 CHR)	\$25.98 R

Marpac Offset Shortside Hinge



- Polished, stamped type 304 stainless steel.
- Thickness .060" gauge.
- Open width 2", pin length 1-1/2", offset 3/8".
- Uses #8 fasteners.
- Sold per pair.

Order No.	Description	Price
7-1005	Offset Shortside Hinge	\$11.98 G

Perko Fig. 1214 Offset Shortside Hinge



- Chrome plated zinc alloy.
- Open width 2-1/2", pin height 1-1/2".
- Shortside width 3/4", offset 3/8".
- Uses #8 fasteners.
- Sold per pair.

Order No.	Mfg. No. / Description	Price
533340	(1214 DP1 CHR)	\$23.98 R

Phoenix Lock Port Hinge



- Cast solid burnished brass.
- Open length 4" L (Open) x 3-1/8" W.
- Uses #10 fasteners (5 screws per hinge).
- Sold per pair.

Order No.	Mfg. No. / Description	Price
547161	(170-4-B)	\$52.98 LQ

Marpac Strap Hinges



- Polished, cast 316 stainless steel.
- Uses #10 fasteners.
- Sold per pair.

Order No.	Description	Price
7-0500	Dimensions: 4" x 1" 4 Screw Holes	\$14.98 G
7-0501	Dimensions: 6" x 1" 6 Screw Holes	\$17.98 G

Marpac Flush Mount Concealed Hinge



- Stamped type 304 stainless steel with satin finish.
- Dimensions: 2-3/4" x 1-7/8".
- Sold per pair.

Order No.	Description	Price
7-0105	Flush Mount Concealed Hinge	\$9.98 G

Perko Fig. 988 Offset Shortside Hinge



- Chrome plated bronze.
- Open width 2-1/4", pin height 1-1/2".
- Shortside width 3/4".
- Offset 3/8".
- Uses #8 fasteners.
- Sold per pair.

Order No.	Mfg. No. / Description	Price
544230	(0988 DP1 CHR)	\$75.98 R

Perko Fig. 942 Offset Hinge



- Chrome plated zinc alloy.
- Open width 1-1/2", pin height 1-1/2".
- Offset 3/8".
- Uses #8 fasteners.
- Sold per pair.

Order No.	Mfg. No. / Description	Price
543746	(0942 DP0 CHR)	\$25.98 R

White Cap Strap Hinge



- Heavy duty stamped 304 stainless steel.
- Uses #8 fasteners.
- All hinges are attractively packaged for display.
- Sold each.

Order No.	Mfg. No. / Description	Price
2011627	(S-3430) 6" L x 1-1/8" W Flathead	\$26.95 G

Marpac Strap Hinges



- Polished, stamped type 304 stainless steel.
- Uses #8 fasteners.
- Sold per pair.

Order No.	Description	Price
7-0455	Dimensions: 4" x 1-3/16"	\$9.98 G
7-0456	Dimensions: 6" x 1-3/16"	\$14.98 G

Perko Fig. 271 Inset Hinge



- Chrome plated stamped brass.
- Semi-concealed for inset doors.
- Dimensions: 2-3/4" x 2-1/2".
- Inset 3/8".
- Uses #4 fasteners.
- Sold per pair.

Order No.	Mfg. No. / Description	Price
536613	(0271 DP0 CHR) Display Pack	\$30.98 R
536601	(0271 000 CHR) Bulk	\$29.98 Q

- Fun & Flotation
- Anchor & Dock
- Safety
- Electronics
- Trolling Motors
- Lighting
- Electrical
- Topside Acc.
- Cockpit & Deck
- Instruments
- Steering, Controls
- Perform.
- Fuel System
- Engine & Parts
- Engine Care
- Propellers
- Seating & Pedestals
- Tops & Covers
- Pumps
- Cleaning & Care
- Paint & Paint Acc.
- Hardware, Fasteners
- Trailering
- Misc.
- Comm.

- Fun & Flotation
- Anchor & Dock
- Safety
- Electronics
- Trolling Motors
- Lighting
- Electrical
- Topside Acc.
- Cockpit & Deck
- Instruments
- Steering, Controls
- Perform.
- Fuel System
- Engine & Parts
- Engine Care
- Propellers
- Seating & Pedestals
- Tops & Covers
- Pumps
- Cleaning & Care
- Paint & Paint Acc.
- Hardware, Fasteners
- Trailer
- Misc.
- Comm.

Marpac Motor Box Hinge



- Chrome plated cast brass.
- Removable.
- Heavy duty.
- Length 3-3/4".
- Width at pin 2".

Order No.	Description	Price
7-0211	Motor Box Hinge	\$12.98 G

Marpac Hatch Hinge



- Chrome plated cast brass.
- Length 2-7/8".
- Width 2-1/2".
- Uses #10 fasteners.

Order No.	Description	Price
7-0212	Hatch Hinge	\$16.98 G

Continuous "Piano" Hinges



ALUMINUM

- Mill finish.
- 3/16" holes drilled on 4" centers.
- Sold in 6' lengths only.

Order No.	Description	Price
740515	Open Width 1-1/2" .040" Gauge	\$15.98
740527	Open Width 2" .040" Gauge	\$23.98

TYPE 304 STAINLESS STEEL BRIGHT ANNEALED

- .040" gauge.
- Drilled and countersunk on 2" centers.
- Sold in 6' lengths only.

Order No.	Description	Price
740565	Open Width 1-1/4" Uses #5 Fasteners	\$36.98
740577	Open Width 1-1/2" Uses #6 Fasteners	\$37.98
740589	Open Width 2" Uses #6 Fasteners	\$48.98

Perko Fig. 957 Non-Mortised Hinge



- Chrome plated stamped brass.
- Easily installs without mortising.
- Closed width 7/8".
- Pin height 3-3/8".
- Uses #8 fasteners.
- Sold per pair.

Order No.	Mfg. No. / Description	Price
543959	(0957 DPO CHR)	\$37.98 R

Uflex AV Series Electrical Hatch Lifter



- According to the load required, the AV hatch lifter can be mounted individually or in twin cylinder installations for heavier loads. It is also possible to install more than two AV actuators in multiple applications.
- Maximum load for single installations: 265 lbs. (not to be exceeded).
- Supplied with all mounting hardware.
- Stainless steel telescopic ram for manual operation in case of emergency.
- Available on request without manual emergency opening device for high performance boats.
- Circuit breaker to stop accidental overloading of the system and electronic stop at closed or full open position.
- IP 65 protection rated.
- Speed: 25mm/sec no load applied, 17 mm/sec maximum load.
- Current absorption in single installations: 10A at 12V, 5A at 24V.
- Ignition Protected. UL1500 - ISO8846 approved.

Order No.	Mfg. No. / Description	Price
2006630	(AV6012) 12 volt, Stroke: 24" Full Closed Actuator: 38.4" L	\$711.98 F

Lenco Electric Hatch Lifts 12-Volt Models



Order No.	Lenco Part#	Superseded Part#	L.O.A. Retract	Approx. Stroke	L.O.A. Extend	Price
252803	20760-001	HL-400	15"	4"	19"	\$281.98 D
252805	20764-001	HL-800S	20"	8"	28"	\$300.98 D
252748	20768-001	HL-1200S	24"	12"	36"	\$323.98 D
252749	20770-001	HL-1200	29"	12"	41"	\$323.98 D
252750	20774-001	HL-1600S	29"	16"	45"	\$369.98 D
252762	20776-001	HL-1600	33"	16"	49"	\$369.98 D
252774	20778-001	HL-2000S	33"	20"	53"	\$399.98 D
252786	20780-001	HL-2000	37"	20"	57"	\$399.98 D
252798	20782-001	HL-2400S	37"	24"	61"	\$423.98 D
252799	20784-001	HL-2400	41"	24"	65"	\$423.98 D
252928	20788-001	HL-3000	47"	30"	77"	\$450.98 D

L.O.A. = Length overall, measuring from top bracket to bottom bracket

Features include:

- ▶ Clear anodized aluminium tubing
- ▶ Clutchless ball screw design will not drift, never binds and runs in sync on dual lift applications
- ▶ Inline motor design delivers over 500 lbs of force
- ▶ Waterproof & non-corrosive materials
- ▶ Ball screw spins freely when hatch is fully opened or closed eliminating limit switches and burned out motors
- ▶ Powdered metal gears for strength and precision
- ▶ Stainless steel ram locks in any position



12-Volt models with 2' leads and deutsch connectors. Includes high impact, corrosion proof mounting brackets and stainless steel pull pins.



OPTIONAL HATCH LIFT ACCESSORIES AVAILABLE BELOW

Order No.	Lenco Part#	Description	Price
252577	15096-001	For Single hatch lift applications Clamshell packaged	\$49.98 E
252580	15098-001	For Dual hatch lift applications Clamshell packaged	\$71.98 E

Single Rocker Switch for Hatch Lifts

Single Rocker Switch for hatch lifts with two 30" non-terminated power leads. For single and dual hatch lift applications



Deutsch Connected Actuator Extension Harnesses Replacement Part



Order No.	Lenco Part #	Description	Price
252655	30133-001D	7' 16-AWG / Clamshell Packaged	\$22.98 E
252659	30133-002D	14' 16-AWG / Clamshell Packaged	\$29.98 E
252661	30133-103D	20' 14-AWG / Clamshell Packaged	\$36.98 E
252936	30142-201	26' 12-AWG / Poly Bagged	\$61.98 D

Deutsch Connected Actuator Extension Harnesses

ABYC Compliant
(Sold individually - one needed per actuator)



Stainless Steel Non-Locking Slide Bracket For use with Hatch Lifts



Order No.	Lenco Part #	Description	Price
252721	70381-001	Stainless Steel Slide Bracket	\$54.98 E

In case of power failure, this bracket allows you to pull the hatch open a minimum of 5' in order to remove bolt for access.

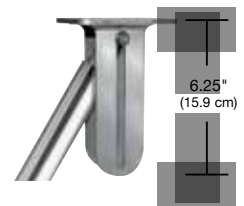

- Fun & Flotation
- Anchor & Dock
- Safety
- Electronics
- Trolling Motors
- Lighting
- Electrical
- Topside Acc.
- Cockpit & Deck
- Instruments
- Steering, Controls
- Perform.
- Fuel System
- Engine & Parts
- Engine Care
- Propellers
- Seating & Pedestals
- Tops & Covers
- Pumps
- Cleaning & Care
- Paint & Paint Acc.
- Hardware, Fasteners
- Trailering
- Misc.
- Comm.

- Fun & Flotation
- Anchor & Dock
- Safety
- Electronics
- Trolling Motors
- Lighting
- Electrical
- Topside Acc.
- Cockpit & Deck
- Instruments
- Steering, Controls
- Perform.
- Fuel System
- Engine & Parts
- Engine Care
- Propellers
- Seating & Pedestals
- Tops & Covers
- Pumps
- Cleaning & Care
- Paint & Paint Acc.
- Hardware, Fasteners
- Trailer
- Misc.
- Comm.

Marpac Gas Spring Hatch Lifts



- Stainless steel.
- Socket End Style.
- The ideal solution for lifting, lowering and counterbalancing weight.
- The gas spring is a self-contained, nitrogen-driven counterbalance product which provides uniform handle forces, non-catastrophic failure and many years of service.
- Because energy is provided through gas pressure, our gas springs give you repeatable, unvarying performance which is superior to mechanical, spring or damper type products.

Order No.	Retracted Length	Approximate Stroke	Extended Length	Output Force	Shaft Diameter	Price
7-1386	5.5"	2"	7.5"	20 lbs.	6mm	\$29.98 G
7-1375	7"	3"	10"	40 lbs.	8mm	\$39.98 G
7-1387	7"	3"	10"	40 lbs.	6mm	\$36.98 G
7-1388	7"	3"	10"	60 lbs.	6mm	\$39.98 G
7-1389	8"	4"	12"	30 lbs.	6mm	\$33.98 G
7-1377	9.5"	5.5"	15"	20 lbs.	8mm	\$41.98 G
7-1390	9.5"	5.5"	15"	40 lbs.	6mm	\$36.98 G
7-1379	9.5"	5.5"	15"	60 lbs.	8mm	\$41.98 G
7-1392	10.2"	7"	17.2"	20 lbs.	6mm	\$37.98 G
7-1381	10.2"	7"	17.2"	40 lbs.	8mm	\$42.98 G
7-1394	12"	8"	20"	60 lbs.	6mm	\$39.98 G
7-1383	12"	8"	20"	90 lbs.	8mm	\$43.98 G
7-1385	12"	8"	20"	120 lbs.	8mm	\$43.98 G

BRACKETS FOR GAS SPRING HATCH LIFTS

Order No.	Description	Price
7-1396	Flat	\$15.98 G
7-1397	2 x .65	\$19.98 G
7-1398	2 x 1.2	\$19.98 G

Attwood Mounting Brackets for Gas Springs



- All quality Attwood "Spring-Lift" mounting brackets are constructed of zinc plated steel with a black painted finish.

Order No.	Mfg. No. / Description	Price
2350214	(SL50BP3-1) Pem Direction: Forward Single	\$5.98 H
2350218	(SL69BS-1) Threaded Stud, 5/16" Threads x 9/16" L	\$6.98 H

White Cap Lid-Lift Gas Springs



- Heavy duty steel coated with heat cured paint.
- O-ring insures proper sealing to force oil towards the orifice piston.
- Piston assembly provides precise control during the extension stroke.
- Sold individually.

Order No.	Mfg. No. / Description	Price
2011540	(G-3120) Extended 7.5" Compressed 5.5" Supports 20 lbs.	\$19.10 H
2011541	(G-3140) Extended 7.5" Compressed 5.5" Supports 40 lbs.	\$19.10 H
2011536	(G-3020) Extended 10" Compressed 7" Supports 20 lbs.	\$19.10 H
2011555	(G-3520) Extended 12" Compressed 8.5" Supports 20 lbs.	\$19.10 H
2011556	(G-3530) Extended 12" Compressed 8.5" Supports 30 lbs.	\$19.10 H
2011542	(G-3320) Extended 15" Compressed 9.5" Supports 20 lbs.	\$19.10 H
2011543	(G-3330) Extended 15" Compressed 9.5" Supports 30 lbs.	\$19.10 H
2011559	(G-3630) Extended 17" Compressed 10.25" Supports 30 lbs.	\$19.10 H
2011562	(G-3660) Extended 17" Compressed 10.25" Supports 60 lbs.	\$19.10 H
2011563	(G-3690) Extended 17" Compressed 11" Supports 90 lbs.	\$19.10 H
2011548	(G-3420) Extended 20" Compressed 12" Supports 20 lbs.	\$19.10 H
2011551	(G-3460) Extended 20" Compressed 12" Supports 60 lbs.	\$19.10 H
2011553	(G-3480) Extended 20" Compressed 12" Supports 80 lbs.	\$19.10 H

ZINC PLATED STEEL BRACKETS - SOLD IN PAIRS

Order No.	Mfg. No. / Description	Price
2011531	(G-1015) 1-3/4" L x 5/8" W x 1-1/4" H	\$5.60 H
2011532	(G-1020) 2-1/2" L x 3/4" W x 1-7/16" H	\$7.25 H
2011534	(G-1060) 2" L x 1-1/4" W x 1" H	\$6.85 H
2011530	(G-1005C) Threaded Ball Stud - Length 1-3/16"	\$4.50 G

BLACK COMPOSITE END FITTINGS - SOLD IN PAIRS

Order No.	Mfg. No. / Description	Price
2011533	(G-1030) Spring Retainer	\$7.70 H
2011535	(G-1130) Snap-On Cap	\$6.75 H

Perko Fig. 762 Hatch Support Brace



Note: Illustration is port side.



- Chrome plated brass.
- One end angled base, the other end flat base.
- Open length 14".
- Uses #8 fasteners.
- Sold per pair.

Order No.	Mfg. No. / Description	Price
542111	(0762 DP3 CHR)	\$155.98 R

T-H Marine Lid and Hatch Support Springs

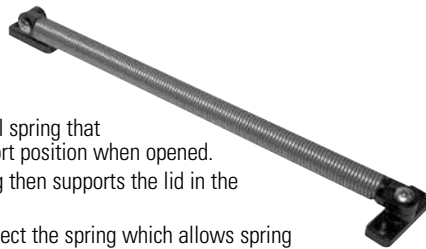

- Features a stainless steel spring that snaps straight to a support position when opened.
- The stainless steel spring then supports the lid in the open position.
- When closing simply deflect the spring which allows spring to bend and rotate at the mounting positions.
- Molded black nylon ends for mounting.

Order No.	Mfg. No.	Diameter	Length	Supports Up to	Price
641060	(LS-2-DP)	7/16"	8-1/2"	10 lbs. Lids	\$15.98 H
642368	(HS-1-DP)	5/8"	12"	20 lbs. Lids	\$28.98 H

Perko Fig. 769 Hatch Fastener or Windshield Keeper



- Chrome plated brass and zinc alloy.
- Black polymer handle.
- Base dimensions: 1-1/2" x 5/8".
- Length overall 4".
- Uses #8 fasteners.

Order No.	Mfg. No. / Description	Price
542123	(0769 DPO CHR)	\$64.98 R

T-H Marine Gate Latches



- Nylon molded part - prevents rattle.
- Entire unit installs on gate only.
- Operates on right or left hinged gates.
- Fits 1", 1-1/8" and 1-1/4" square tubing.
- Not designed as a safety or load bearing device.

Order No.	Mfg. No. / Description	Price
247750	(GL-1-DP) Black	\$14.98 Q
247751	(GL-2-DP) Gray	\$14.98 Q

Boater Sports Hatch Support Spring



- Stainless steel hatch spring holds open hatches, doors, table leaves etc.
- Holds up to 10 lbs.

Order No.	Mfg. No. / Description	Price
1-54208	(54208) Length 8"	\$7.95 H

Perko Fig. 797 Hatch Adjuster



- Chrome plated brass and zinc alloy with black polymer knob.
- Arm length 10".
- Length adjustment 9-1/2".
- Slide length 10-3/4".
- Uses #8 fasteners.

Order No.	Mfg. No. / Description	Price
542301	(0797 DPO CHR)	\$126.98 R

Perko Fig. 770 Hatch Fastener



- Chrome plated bronze.
- Black polymer knob.
- Overall dimensions: 3-1/2" x 1-5/8".
- Adjustment thread 7/8".
- Uses #8 fasteners.

Order No.	Mfg. No. / Description	Price
542135	(0770 DPO CHR)	\$82.98 R

T-H Marine Windshield Fastener



- Molded of UV stable polymer that will not corrode.
- Makes installing and removing the windshield simple.
- Base mounts to the boat and the quick twist fastener passes thru windshield.
- Great for preventing broken windshields in shipping, installation and for cleaning.
- Two male configurations: wing nut style, slotted flush head.
- Includes: Windshield fasteners, wing nut head and base.
- Per pair.

Order No.	Mfg. No. / Description	Price
642374	(WSH-1PR-DP)	\$11.98 H

- Fun & Flotation
- Anchor & Dock
- Safety
- Electronics
- Trolling Motors
- Lighting
- Electrical
- Topside Acc.
- Cockpit & Deck
- Instruments
- Steering, Controls
- Perform.
- Fuel System
- Engine & Parts
- Engine Care
- Propellers
- Seating & Pedestals
- Tops & Covers
- Pumps
- Cleaning & Care
- Paint & Paint Acc.
- Hardware, Fasteners
- Trailering
- Misc.
- Comm.

- Fun & Flotation
- Anchor & Dock
- Safety
- Electronics
- Trolling Motors
- Lighting
- Electrical
- Topside Acc.
- Cockpit & Deck
- Instruments
- Steering, Controls
- Perform.
- Fuel System
- Engine & Parts
- Engine Care
- Propellers
- Seating & Pedestals
- Tops & Covers
- Pumps
- Cleaning & Care
- Paint & Paint Acc.
- Hardware, Fasteners
- Trailer
- Misc.
- Comm.

Boater Sports Windshield Fastener



- Black nylon.
- Windshield quick release fasteners make removing and installing windshield easy.

Order No.	Mfg. No. / Description	Price
1-54211	(54211)	\$6.95 H

Taylor Made Turn Latch



- A simple twist latch for securing walk-thru windshields or other hatch openings.
- Black thermoplastic complete with self-tapping screws.
- Sold 2 per pack.

Order No.	Mfg. No. / Description	Price
722606	(1162)	\$6.98 LQ

Perko Figs. 1290 and 1291 Windshield Adjusters



Note: Illustration is port side.



534087



534102



- Chrome plated zinc alloy.
- Black polymer knob.
- Length overall 12" with 9-1/2" adjustment.
- Uses #8 fasteners.
- Sold per pair.

Order No.	Mfg. No. / Description	Price
534087	(1290 DPO CHR) Side Mount	\$99.98 R
534102	(1291 DPO CHR) Offset Mount	\$99.98 R

Taylor Made Windshield Support Bars



- Used as original equipment on many fine walk-thru windshields.
- Made from anodized aluminum tubing with nylon fittings.
- The fittings allow for pivot in almost every direction for easy installation.
- Sold in single units.

Order No.	Mfg. No. / Description	Price
723535	(1632) Length 11"	\$22.98 R
723537	(1634) Length 12"	\$22.98 R
723536	(1636) Length 13"	\$22.98 R

Perko Fig. 967 Hatch Fastener or Windshield Keeper



- Chrome plated bronze.
- Keeper: 1-7/8" x 7/8".
- Bracket: 1-9/16" x 1".
- Bolt length 1-1/2".
- Uses #8 fasteners.

Order No.	Mfg. No. / Description	Price
544040	(0967 DPO CHR) Display Pack	\$91.98 R
544037	(0967 000 CHR) Bulk	\$90.98 Q
546929	(0967DPOCHR)	\$102.98 R

Perko Fig. 935 Sliding Window Stop



- Chrome plated zinc alloy with polymer cover on stopping plate.
- Stopping plate length 1-1/2".
- Mounting plate dimensions: 1-7/8" x 3/4".
- Uses #8 fasteners.

Order No.	Mfg. No. / Description	Price
543668	(0935 DPO CHR)	\$19.98 R

Perko Fig. 1116 Windshield Adjuster



- Chrome plated brass and zinc alloy.
- Black polymer knob. Rod: 3/8" OD x 12" L.
- Uses #8 fasteners.
- Sold each.

Order No.	Mfg. No. / Description	Price
532108	(1116 DP3 CHR)	\$90.98 R

Handi-Man Windshield Support Tube



- Designed to fit many bow rider style boats, with walk through windshield.
- Black anodized aluminum tube resists corrosion.

Order No.	Mfg. No. / Description	Price
7270025	(01625) Overall Length 14"	\$26.98 H

Marpac Chrome Plated Brass Hold Down Clamp



- Chrome plated brass.
- Base dimensions: 1-3/4" x 2-3/4". Length 4".

Order No.	Description	Price
7-0214	Hold Down Clamp	\$12.98 G

Perko Fig. 1112 Hold Down Clamp



- Chrome plated bronze.
- Flat mounting.
- Dimensions: 1-1/2" W x 3" L.
- Uses #8 fasteners.

Order No.	Mfg. No. / Description	Price
532057	(1112DPOCHR)	\$93.98 R

Marpac T-Handle Latch



- Flexible.
- Non-corrosive, non-conductive, UV resistant materials.
- Compensates for misalignment in 3 planes.
- Built-in drag keeps latch stationary when unlatched.
- Length 4.81".

Order No.	Description	Price
7-2255	T-Handle Latch	\$12.98 G

Marpac Hand Rail Bases



- 316 stainless steel hand rail bases.
- Fittings for 7/8" OD tubing have 1-1/2" base.
- Fittings for 1" OD tubing have 1-3/4" base.
- Have no set screw.

Order No.	Description	Price
7-0187	Forward 120° For 7/8" OD Tubing	\$11.98 G
7-0188	Center 60° For 7/8" OD Tubing	\$9.98 G
7-0189	Aft 60° For 7/8" OD Tubing	\$10.98 G
7-0987	Forward 120° For 1" OD Tubing	\$13.98 G
7-0988	Center 60° For 1" OD Tubing	\$14.98 G
7-0989	Aft 60° For 1" OD Tubing	\$12.98 G

Marpac Stainless Steel Hold Down Clamps



- Stainless steel.

Order No.	Description	Price
7-0223	Dimensions: 3" L x 1-1/2" W	\$23.98 G
7-0225	Dimensions: 4" L x 1-7/8" W x 1" H	\$16.98 G
7-0224	Dimensions: 2-1/2" L x 1-1/2" W, 90° Angle Mounting	\$22.98 G

Marpac Draw Latch



- Thermoplastic elastomer, black.
- Soft latch, small size.
- Non-corrosive materials.
- Over-center latching.
- Cushions impact, absorbs vibration, tolerates misalignment.
- Concealed keeper style.
- Dimensions: 4" x 1-1/2".

Order No.	Description	Price
7-2250	Draw Latch	\$25.98 G

White Cap Chrome Plated Rail Stanchion



- These patented rail stanchions are ideal for top, bow, side, stern or hand rails.
- Accommodates 7/8" OD tubing.
- Packaged for display.

Order No.	Mfg. No. / Description	Price
2011586	(S-1488C) Aft	\$8.35 H

Perko Fig. 380 Grab Rail Posts



- Chrome plated bronze.
- Hollow, for 1" OD tubing.
- Height overall 3-3/8".
- Base OD 2-1/2".
- Uses #8 fasteners.

Order No.	Mfg. No. / Description	Price
537994	(0380 000 CHR) End Post	\$98.98 Q
538009	(0380 A00 CHR) Center Post	\$99.98 Q

- Fun & Flotation
- Anchor & Dock
- Safety
- Electronics
- Trolling Motors
- Lighting
- Electrical
- Topside Acc.
- Cockpit & Deck
- Instruments
- Steering, Controls
- Perform.
- Fuel System
- Engine & Parts
- Engine Care
- Propellers
- Seating & Pedestals
- Tops & Covers
- Pumps
- Cleaning & Care
- Paint & Paint Acc.
- Hardware, Fasteners
- Trailering
- Misc.
- Comm.

- Fun & Flotation
- Anchor & Dock
- Safety
- Electronics
- Trolling Motors
- Lighting
- Electrical
- Topside Acc.
- Cockpit & Deck
- Instruments
- Steering, Controls
- Perform.
- Fuel System
- Engine & Parts
- Engine Care
- Propellers
- Seating & Pedestals
- Tops & Covers
- Pumps
- Cleaning & Care
- Paint & Paint Acc.
- Hardware, Fasteners
- Trailer
- Misc.
- Comm.

Marpac Cast Stainless Steel Rail Fittings - 30° Round Base



- Heavy duty cast type
316 marine grade stainless steel.
- Includes set screw.
- Skin packed.

Order No.	Description	Price
7-0178	7/8" OD Tubing 2-5/8" Uses #10 Fasteners	\$14.98 G
7-0978	1" OD Tubing 2-7/8" Uses 1/4 Fasteners	\$14.98 G

White Cap Die Case Zamak 60° Round Base



- Fits 7/8" tubing.
- Set screws included.
- Packaged for display.

Order No.	Mfg. No. / Description	Price
2011583	(S-1467C)	\$9.25 H

Marpac Cast Stainless Steel Rail Fittings - 30° Rectangular Base



- Heavy duty cast type
316 marine grade stainless steel.
- Includes set screw.
- Skin packed.

Order No.	Description	Price
7-0181	7/8" OD Tubing 2-5/8" Uses #10 Fasteners	\$14.98 G

Marpac Cast Stainless Steel Rail Fittings - 90° Rectangular Base



- Heavy duty cast type
316 marine grade stainless steel.
- Includes set screw.
- Skin packed.

Order No.	Description	Price
7-0183	7/8" OD Tubing Uses #10 Fasteners	\$16.98 H
7-0983	1" OD Tubing Uses 1/4 Fasteners	\$15.98 G

Marpac Cast Stainless Steel Rail Fittings - 90° Tee



- Heavy duty cast type
316 marine grade stainless steel.

Order No.	Description	Price
7-0186	7/8" OD Tubing	\$13.98 G
7-0986	1" OD Tubing	\$14.98 G

Marpac Cast Stainless Steel Rail Fittings - 90° Elbows



- Heavy duty cast type
316 marine grade stainless steel.

Order No.	Description	Price
7-0192	7/8" OD Tubing	\$12.98 G
7-0992	1" OD Tubing	\$12.98 G

Marpac Cast Stainless Steel Rail Fittings - 60° Round Base



- Heavy duty cast type
316 marine grade stainless steel.
- Includes set screw.
- Skin packed.

Order No.	Description	Price
7-0179	7/8" OD Tubing 2-5/8" Uses #10 Fasteners	\$16.98 G
7-0979	1" OD Tubing 2-3/16" Uses 1/4 Fasteners	\$15.98 G

Marpac Cast Stainless Steel Rail Fittings - 90° Round Base



- Heavy duty cast type
316 marine grade stainless steel.
- Includes set screw.
- Skin packed.

Order No.	Description	Price
7-0180	7/8" OD Tubing 2-5/8" Uses #10 Fasteners	\$16.98 G
7-0980	1" OD Tubing 2-3/4" Uses 1/4 Fasteners	\$15.98 G

Marpac Cast Stainless Steel Rail Fittings - 60° Rectangular Base



- Heavy duty cast type
316 marine grade stainless steel.
- Includes set screw.
- Skin packed.

Order No.	Description	Price
7-0182	7/8" OD Tubing Uses #10 Fasteners	\$16.98 G
7-0982	1" OD Tubing Uses 1/4 Fasteners	\$15.98 G

Marpac Cast Stainless Steel Rail Fittings - 60° Tee



- Heavy duty cast type
316 marine grade stainless steel.

Order No.	Description	Price
7-0202	7/8" OD Tubing	\$12.98 G
7-1002	1" OD Tubing	\$13.98 G

White Cap Die Cast Zamak 60° Rail Tees



- Fits 7/8" tubing.
- Set screws included.
- Packaged for display.

Order No.	Mfg. No. / Description	Price
2011577	(S-1441C) Left Hand	\$9.35 H
2011578	(S-1442C) Right Hand	\$9.35 H

Marpac Cast Stainless Steel Rail Fitting - 110° Bow Form



- Heavy duty cast type
316 marine grade stainless steel.

Order No.	Description	Price
7-0190	7/8" OD Tubing	\$23.98 G

White Cap Chrome Plated Zamak 5-1/2" Blend Base



- Fits 7/8" tubing.
- Set screws included.
- Packaged for display.

Order No. Mfg. No. / Description Price
2011590 (S-1495C) **\$10.95** H

White Cap Set Screws



- These headless socket set screws are 1/4"-28 x 3/16".
- Hex drive.
- For die-cast rails.
- Sold 10 per pack.

Order No. Mfg. No. / Description Price
2011524 (6249C) **\$4.95** H

T-H Marine Grab Handles



- Molded, UV resistant grab handles.
- Soft overmold on firm handle.
- Textured for sure grip.
- Rubberized ergonomic feel.
- Hidden fasteners.
- Center of screw to center of screw measures 7-1/4".

Order No. Mfg. No. / Description Price
327318 (GHB-1-DP) Black **\$10.98** H
327319 (GHB-1FW-DP) White **\$11.98** H
327320 (GHB-1G-DP) Graphite **\$12.98** I

Detmar Soft Grip Grab Handle



- This functionally styled grab handle may be used as an economical safety device throughout passenger areas.
- Leather grained for a comfortable, no-slip grip.
- Grab handle mounts using two 1/4" machine or wood screws.
- Once installed, decorative caps snap over mount holes to hide fasteners.
- Dimensions: 9-1/4" L x 2-1/4" H x 1-3/16" W with 1-5/8" finger clearance.

Order No. Mfg. No. / Description Price
2000537 (12-1132) Black **\$9.98** H

White Cap Hand Rail Stanchions



- 304 stainless steel.

Order No. Mfg. No. / Description Price
2011651 (S-7091P) Length 12" Includes 1/4-20 Studs **\$39.95** H
2011653 (S-7094) Length 12" w/o Studs, Requires 1/4" Fastener **\$19.95** H

Taco Marine Tubing for Rail Fittings



ALUMINUM TUBING

- Brite anodized finish.

Order No.	Description	Price
741909	7/8" x 6' Wall Thickness .058"	\$45.98 I
741911	7/8" x 20' Wall Thickness .058"	\$114.98 I

STAINLESS STEEL TUBING

- High polished, type 304.

Order No.	Description	Price
741935	7/8" x 6' Wall Thickness .049"	\$50.98 I
741947	7/8" x 20' Wall Thickness .065"	\$205.98 H
741973	1" x 6' Wall Thickness .049"	\$49.98 I
741985	1" x 20' Wall Thickness .065"	\$259.98 I

Attwood Flexible Grab Handle



- Constructed from soft polypropylene webbing over a semi-rigid core.
- All materials are non-corrosive, UV stable and mildew-resistant.
- Flexible grab handle for flush, flexible mounting.
- Can be mounted to a variety of irregular surfaces and angles on swim platform, in the cockpit and companionway.
- Because of the soft, pliable webbing in these handles and the absence of any sharp edges, they are safe in areas where occupants might come in contact with them.
- Four holes for required #12 fasteners.

Order No. Mfg. No. / Description Price
2350189 (2061-1) **\$10.98** H

Detmar Snap Cover Grab Handle



- Attractively styled, this hard grip handle has integrated, hinged caps which snap over the mount holes so no fasteners are visible after mounting.
- No loose caps make installation handling easier and eliminate cap loss.
- Textured to blend with any interior or exterior application.
- 2-hole for 1/4" machine or wood screws.
- Dimensions: 9" L x 2-3/16" H x 1-1/8" W with 1-1/2" finger clearance.

Order No. Mfg. No. / Description Price
2000538 (12-1300) Black **\$6.98** H

Marpac Utility Transom Handle



- Heavy duty cast marine grade stainless steel.
- Use #10 fasteners.
- Dimensions: 5-7/8" L x 1-15/16" W x 1-13/16" H.

Order No. Description Price
7-0648 Utility Transom Handle **\$11.98** G

- Fun & Flotation
- Anchor & Dock
- Safety
- Electronics
- Trolling Motors
- Lighting
- Electrical
- Topside Acc.
- Cockpit & Deck
- Instruments
- Steering, Controls
- Perform.
- Fuel System
- Engine & Parts
- Engine Care
- Propellers
- Seating & Pedestals
- Tops & Covers
- Pumps
- Cleaning & Care
- Paint & Paint Acc.
- Hardware, Fasteners
- Trailering
- Misc.
- Comm.

- Fun & Flotation
- Anchor & Dock
- Safety
- Electronics
- Trolling Motors
- Lighting
- Electrical
- Topside Acc.
- Cockpit & Deck
- Instruments
- Steering, Controls
- Perform.
- Fuel System
- Engine & Parts
- Engine Care
- Propellers
- Seating & Pedestals
- Tops & Covers
- Pumps
- Cleaning & Care
- Paint & Paint Acc.
- Hardware, Fasteners
- Trailer
- Misc.
- Comm.

Perko Fig. 775 Handles



- Chrome plated bronze.
- Sold per pair.

LENGTH OVERALL 4-1/4"

- Length inside 2-1/2".
- Height inside 7/8".
- Uses #6 fasteners.

Order No.	Mfg. No. / Description	Price
547452	(0775DP1CHR)	\$73.98 R

LENGTH OVERALL 5-3/4"

- Length inside 3-5/8".
- Height inside 1-3/8".
- Uses #8 fasteners.

Order No.	Mfg. No. / Description	Price
542161	(0775 DP2 CHR)	\$99.98 R

Perko Fig. 344 Folding Step



- Chrome plated manganese bronze.
- Stainless steel spring holds step in open or closed position.
- Step dimensions: 4-1/8" x 2-1/4".
- Bracket dimensions: 4-1/4" x 1-3/4".
- Folded projection 1-3/8".
- Uses 5/16" R.H. fasteners.

Order No.	Mfg. No. / Description	Price
537603	(0344 DPO CHR)	\$185.98 R

Perko Fig. 975 Coat and Hat Hooks



- Chrome plated zinc alloy.
- Uses #6 fasteners.

Order No.	Mfg. No.	Base Width: 1-1/8"	Projection: 2"	Price
544139	(0975 DP1 CHR)			\$7.98 R
544141	(0975 DP2 CHR)	Base Width: 1-1/4"	Projection: 3"	\$8.98 R

Perko Fig. 1222 Handle



- Chrome plated zinc alloy.
- Length overall 5-3/4".
- Inside dimensions: 3-5/8" L x 1-1/4" H.
- Uses #8 fasteners.
- Sold per pair.

Order No.	Mfg. No. / Description	Price
533439	(1222 DPO CHR)	\$18.98 Q

Perko Fig. 1231 Handle



- Chrome plated zinc alloy.
- Length overall 6".
- Inside dimensions: 3-1/2" L x 1-5/16" H.
- Uses 1/4" fasteners.
- Sold per pair.

Order No.	Mfg. No. / Description	Price
533617	(1231 DPO CHR)	\$25.98 R

Perko Fig. 610 Wardrobe or Utility Hook



- Chrome plated zinc alloy.
- Base width 1-1/8".
- Projection 1-3/8".
- Uses #6 fasteners.

Order No.	Mfg. No. / Description	Price
541195	(0610 DPO CHR)	\$6.98 R

Boatmates Utility Hook



- Suction mounts in cockpit, cabin or fly bridge.
- Hook holds lines, leaders, clothing, towels or a wet bathing suit.
- Stick it up when you need it, stow it away when you don't.
- Dimensions: 3" H x 1" W x 1-1/2" D.

Order No.	Mfg. No. / Description	Price
500971	(2100-2) White	\$9.98 LQ

Marpac Stainless Steel Hollow Base Cleats



- Polished stainless steel.
- Fastens with 1/4" screws.

Order No.	Description	Price
7-0169	Length 4-1/2"	\$9.98 G
7-0170	Length 6"	\$13.98 G
7-0171	Length 8"	\$20.98 G
7-0172	Length 10"	\$32.98 G

Buck Algonquin Stainless Steel Open Base Cleat



- Polished 316 stainless steel.
- Predrilled with four holes.
- Base dimensions: 1-3/8" W x 4" L.
- Overall length 14-7/8".
- Overall height 3-15/16".

Order No.	Mfg. No. / Description	Price
263378	(70COBS1500)	\$237.98 H

Marpac Galvanized Standard Dock Cleats



- Hot dipped galvanized gray iron.
- Measured from tip to tip.

Order No.	Mfg. No. / Description	Price
7-2290B	Length 4"	\$1.99 H
7-2292B	Length 6"	\$2.50 H
7-2294B	Length 8"	\$4.50 H
7-2296B	Length 10"	\$6.98 H
7-2298B	Length 12"	\$10.98 H

Sea Dog Chrome Zamak Hollow Base Cleats



- Die cast zinc chrome plated.
- Predrilled with four holes.

Order No.	Mfg. No. / Description	Price
239598	(044104-1) Length 4-1/2"	\$5.98 Q
239601	(044106-1) Length 6"	\$13.98 Q

Perko Fig. 1210 Open Base Cleat



- Chrome plated zinc alloy.
- Stainless steel studs, nuts and washers.
- Length overall 6".
- Base dimensions 3" x 1-3/4", maximum rope size 7/16".

Order No.	Mfg. No. / Description	Price
5315047	(1210 006 CHR)	\$30.98 H

Perko Fig. 1306 Chromalex® Open Base Cleats



- Chrome plated zinc alloy with black polymer base.

LENGTH 4-1/2"

Order No.	Mfg. No. / Description	Price
534277	(1306 DP1 CHR) Sold Per Pair	\$24.98 R

LENGTH 6"

Order No.	Mfg. No. / Description	Price
534289	(1306 DP2 CHR) Sold Each	\$24.98 R

Perko Fig. 530 Aluminum Open Base Cleats



- Heavy duty aluminum.

Order No.	Mfg. No. / Description	Price
540472	(0530 008 ALU) Length 8"	\$42.98 Q
540484	(0530 010 ALU) Length 10"	\$65.98 Q
540496	(0530 012 ALU) Length 12"	\$109.98 Q

Marpac Deluxe Pull Up Cleats



- Use only a drill or hole saw for installation.
- Closed position only 1/2" above deck.
- Water resistant O-ring included.
- Wider finger grip for ease of use.
- Eliminates standing water on base.

Order No.	Description	Price
7-1017	Length 4" Slim Line Design	\$59.98 G
7-1018	Length 6" Wide Base Design	\$69.98 G

Perko Fig. 545 Aluminum Plain Finished Cleats



- Pressure cast aluminum.

CLOSED BASE

Order No.	Mfg. No. / Description	Price
540725	(0545 DP6 ALU) Length 6"	\$18.98 R

OPEN BASE

Order No.	Mfg. No. / Description	Price
540737	(0545 DP8 ALU) Length 8"	\$24.98 R

Marpac High Impact Nylon Cleats



- Durable high impact black nylon yacht cleats.

Order No.	Description	Head Screws	Price
7-0340	Length 4-1/2"	#10 Oval Machine	Sold 2 Per Card \$3.49 G
7-0340B	Length 4-1/2"	#10 Oval Machine	Bulk - Sold Each \$2.98 I
7-0340S	Length 4-1/2"	#10 Oval Machine	Bucket of 24 Cleats \$27.98 G
7-0341	Length 6"	1/4" Oval Machine	Sold 2 Per Card \$3.99 G
7-0341B	Length 6"	1/4" Oval Machine	Bulk - Sold Each \$3.04 I
7-0341S	Length 6"	1/4" Oval Machine	Bucket of 24 Cleats \$35.98 G
7-0338	Length 8"	1/4" Oval Machine	Sold 2 Per Card \$6.98 G
7-0338B	Length 8"	1/4" Oval Machine	Bulk - Sold Each \$4.97 I
7-0339	Length 10"	5/16" Oval Machine	Sold 2 Per Card \$9.98 G
7-0339B	Length 10"	5/16" Oval Machine	Bulk - Sold Each \$7.98 I



Fun & Flotation

Anchor & Dock

Safety

Electronics

Trolling Motors

Lighting

Electrical

Topside Acc.

Cockpit & Deck

Instruments

Steering, Controls

Perform.

Fuel System

Engine & Parts

Engine Care

Propellers

Seating & Pedestals

Tops & Covers

Pumps

Cleaning & Care

Paint & Paint Acc.

Hardware, Fasteners

Trailering

Misc.

Comm.

Perko Fig. 1057 Rope Deck Pipe



- High impact black polymer.
- UV stabilized, fiber reinforced.
- Hinged, snap-down cover.
- Maximum rope size: 7/8". Flange OD 3-3/4".
- Uses #8 fasteners.

Order No.	Mfg. No. / Description	Price
531585	(1057 DPO BLK)	\$22.98 R

Perko Fig. 757 Rope Deck Pipe



- Chrome plated zinc alloy.
- Hinged, snap-down cover.
- Maximum rope size: 1". Flange OD 3-3/8".
- Uses #8 fasteners.

Order No.	Mfg. No. / Description	Price
542009	(0757 DPO CHR)	\$35.98 R

Marpac Rope Deck Pipe



- Cast stainless steel.
- Base dimensions: 5-5/8" x 4-1/16".

Order No.	Description	Price
7-0941	Rope Deck Pipe	\$82.98 G

Perko Fig. 752 Oval Hawse Hole Plate



- Chrome plated bronze.
- Eliminate deck and rope chaffing when cleats are mounted on a vertical surface inside cockpits.
- Outside dimensions: 4-1/4" x 6".
- Inside dimensions: 2-1/8" x 4-1/8".
- Spigot length 1-1/4".
- Uses 1/4" fasteners.

Order No.	Mfg. No. / Description	Price
541967	(0752 000 CHR)	\$152.98 Q

Marpac Straight Chock



- Stainless steel.
- Length 5".
- Sold per pair.

Order No.	Description	Price
7-0940	Straight Chock	\$27.98 G

Marpac Bow Chock



- Polished, type 316 cast stainless steel.
- Length 4-1/2".
- Sold per pair.

Order No.	Description	Price
7-0173	Bow Chock	\$28.98 G

Perko Fig. 1223 Skene Bow Chock



- Chrome plated zinc alloy.
- Maximum rope size: 1/2".
- Overall length 3-1/2". Width 7/8".
- Uses #8 fasteners.

Order No.	Mfg. No. / Description	Price
533453	(1223 DPO CHR)	\$13.98 R

Accon Folding Chocks

Accon Marine



- Folds down when not in use.
- Marine grade 316 stainless steel.
- Surface mount - no cut-out required.

Order No.	Mfg. No. / Description	Price
S/O	(502-4) Length 4-1/2"	Price on Request
S/O	(502-6) Length 6"	Price on Request

Accon Pop-Up® Chocks

Accon Marine



- Chock easily pulls up for use.
- Simply press it down when not needed to keep deck clutter free.
- Made of marine grade 316 stainless steel.
- Fastens to deck with two #10 screws (not included).

Order No.	Mfg. No. / Description	Price
S/O	(500) 4-1/2" Set of Port & Starboard Chocks	Price on Request
S/O	(500-6) 6" Set of Port & Starboard Chocks	Price on Request
S/O	(501) 4-1/2" Straight Stern Chock	Price on Request
S/O	(501-6) 6" Straight Stern Chock	Price on Request
S/O	(500-DF) Drain Fitting	Price on Request
S/O	(500-DP) Drain Plug	Price on Request

T-H Marine Rugged Duty Unilok Mount



Order No.	Mfg. No. / Description	Price
642480	(EM-1205-DP) 5"	\$53.98 LQ

Marpac Stern Eyes



- Large backing plate helps distribute loads.
- All stainless steel.
- Mounting nuts included.

Order No.	Description	Price
7-0124	3/8" x 3" L	\$7.98 G
7-0123	1/2" x 3-7/16" L	\$11.98 G

Marpac Bow Eyes



- Rounded plates won't gouge fiberglass.
- All stainless steel.
- Mounting nuts included.

Order No.	Description	Price
7-0122	3/8" x 3" L	\$8.98 G
7-0120	1/2" x 3-7/16" L	\$9.98 G

Boater Sports Stainless Steel Bow/Stern Eyes



- 316 stainless steel.
- For use on the bow or stern.
- Stainless steel finishing plates.
- Washers and nuts included.

Order No.	Mfg. No. / Description	Price
1-54102	(54102) 3/8" x 4-7/8"	\$9.95 H
1-54104	(54104) 1/2" x 5-1/4"	\$15.95 H

Boater Sports Bow/Stern Eye



- Zamak chrome plated eye.
- Cadmium plated shanks, nut and washer.
- 1-1/2" ID eye hole.
- 3/8" shank.
- 3" and 5" Shank included.

Order No.	Mfg. No. / Description	Price
1-54134	(54134)	\$6.99 H

Sea Dog Single Shank Bow Eyes



- Die cast chrome zinc head with galvanized shaft.
- Maximum straight axis pull weight: 2,500 lbs.

Order No.	Mfg. No. / Description	Price
239459	(079133-1) 3-1/16" 3/8" Stud	\$7.98 Q
239423	(079135-1) 4-5/8" 3/8" Stud	\$7.98 Q

Boater Sports Twin Shank Bow Eye



- Zamak chrome plated.
- For use on the bow or stern.
- Washers and nuts included.
- 3/8" x 4-7/8".

Order No.	Mfg. No. / Description	Price
1-54135	(54135)	\$10.85 H

Perko Fig. 1235 Double Shank Bow Eye



Note: Not designed to bear the weight of the vessel and therefore should not be used for lifting.

- Chrome plated zinc alloy eye.
- Zinc alloy plated steel U-bolt, nuts and washers.
- Has one continuous U-bolt cast inside of eye.
- Shank OD 5/16". Length 3". Eye ID 1".
- Safe working load 2,000 lbs.

Order No.	Mfg. No. / Description	Price
533643	(1235 DPO CHR)	\$21.98 R

White Cap U-Bolt Bow Eye



- Constructed of 304 stainless steel.
- Display packaged.

Order No.	Mfg. No. / Description	Price
2011632	(S-5022P) 3/8" Stock 1" ID 3-7/16" Threads	\$15.95 H

- Fun & Flotation
- Anchor & Dock
- Safety
- Electronics
- Trolling Motors
- Lighting
- Electrical
- Topside Acc.
- Cockpit & Deck
- Instruments
- Steering, Controls
- Perform.
- Fuel System
- Engine & Parts
- Engine Care
- Propellers
- Seating & Pedestals
- Tops & Covers
- Pumps
- Cleaning & Care
- Paint & Paint Acc.
- Hardware, Fasteners
- Trailer
- Misc.
- Comm.

- Fun & Flotation
- Anchor & Dock
- Safety
- Electronics
- Trolling Motors
- Lighting
- Electrical
- Topside Acc.
- Cockpit & Deck
- Instruments
- Steering, Controls
- Perform.
- Fuel System
- Engine & Parts
- Engine Care
- Propellers
- Seating & Pedestals
- Tops & Covers
- Pumps
- Cleaning & Care
- Paint & Paint Acc.
- Hardware, Fasteners
- Trailer
- Misc.
- Comm.

Marpac Lifting Eye with Cleat



- Polished, type 316 cast stainless steel.
- Threaded for 5/8" - 11 rod.
- Sold each.

Order No.	Description	Price
7-0176	Lifting Eye with Cleat	\$29.98 G

Marpac Lifting Eye



- Polished 316 stainless steel.
- Tapped for 5/8" connecting rods.
- Large 1-1/2" inside diameter eye.
- Lifting eye with O-ring.

Order No.	Description	Price
7-0177	Lifting Eye	\$29.98 G

Marpac Adjustable Keel Plate



- Cast stainless steel.
- Shank dimensions: 3/8" x 3".
- Uses 5/8" threaded rod.

Order No.	Description	Price
7-0125	Adjustable Keep Plate	\$39.98 G

Stainless Steel All Threaded Rod



- Length 3'.

Order No.	Description	Price
731479	10-24	\$7.98 L
731481	1/4-20	\$8.98 L
731483	5/16-18	\$13.98 L
731485	3/8-16	\$18.98 L
731487	1/2-13	\$35.98 L
731489	5/8-11	\$37.98 L
731491	3/4-10	\$93.98 L

Accon Oval Lifting Eye

Accon Marine



- Small compact unit.
- Unit can be drained or sealed water tight.
- Hub pivots two ways to overcome a slight misalignment at installation.
- All stainless steel parts; eye and base are 316, lifting hardware is 304.
- The sling is a solid casting for increased strength.
- Requires less clearance under deck than our lifting cleats.
- Fastens to deck with four #10 screws.

Order No.	Mfg. No. / Description	Price
S/O	(201-EA) Complete Assembly	Price on Request
S/O	(201-LE) Lift Eye with Base	Price on Request
S/O	(201-LER) Rod	Price on Request
S/O	(203-S) Sling	Price on Request
S/O	(203-CBL) Cross Bar for Sling	Price on Request
S/O	(203-BE) Bow Eye	Price on Request

Accon Round Lifting Eye

Accon Marine



- All stainless steel parts.
- Eye and base are 316, lifting hardware is 304.
- The sling is a solid casting for increased strength.
- 2-3/8" hole required.
- Fastens to deck with four #10 screws (not included).
- Standard rod length is 12".
- The maximum working load is 4,000 lbs. in the direction of the axis of the threaded rod shank only.
- Test results available upon request.

Order No.	Mfg. No. / Description	Price
S/O	(203-EA) Complete Assembly	Price on Request
S/O	(203-LE) Lift Eye with Base	Price on Request
S/O	(203-LER) Rod	Price on Request
S/O	(203-S) Sling	Price on Request
S/O	(203-CBR) Cross Bar for Sling	Price on Request
S/O	(203-BE) Bow Eye	Price on Request

Accon Extra Large Round Lifting Eye

Accon Marine



- All stainless steel parts; eye and base are 316, lifting hardware is 304.
- The sling is a solid casting for increased strength.
- Parts may be purchased separately.
- 3-1/4" diameter hole required.
- Fastens to deck with four 1/4" screws.

Order No.	Mfg. No. / Description	Price
S/O	(203-EA-XL) Complete Assembly	Price on Request
S/O	(203-XL) Lift Eye with Base	Price on Request
S/O	(203-BE) Bow Eye	Price on Request

Accon Lifting Eye Accessories

Accon Marine



Order No.	Mfg. No. / Description	Price
S/O	(201-DP) Drain Plug	Price on Request
S/O	(201-DF) Drain Fitting	Price on Request
S/O	(209-PA) Pivot Attachment	Price on Request