

Marpac Stainless Steel Drain Plugs



- Corrosion resistant stainless steel handle.
- Neoprene plug for a non-slip leakproof seal.

Order No.	Description	Price
7-0563	Snap Drain Plug 1"	\$3.98 G
7-0563S	Snap Drain Plug 1" (Bucket of 50)	\$134.98 G
7-0565	Snap Drain Plug 1-1/4"	\$5.98 G
7-0564	Twist Drain Plug 1"	\$3.08 G
7-0564S	Twist Drain Plug 1" (Bucket of 50)	\$129.98 G
7-0567	Twist Drain Plug 1-1/4"	\$5.98 G

Marpac Brass Drain Plugs



- Brass handle.
- Neoprene plug.
- Size 1".

Order No.	Description	Price
7-0093	Snap Drain Plug	\$3.29 G
7-0093S	Snap Drain Plug (Bucket of 50)	\$112.98 G
7-0094	Twist Drain Plug	\$2.98 G
7-0094S	Twist Drain Plug (Bucket of 50)	\$112.98 G

Boater Sports Twist Type Drain Plugs



- Twist type drain plugs are for 1" transom tubes.
- Offers the smooth, tight seal.

Order No.	Mfg. No. / Description	Price
1-54804	(54804) 1" Stainless Steel Packaged Each	\$4.33 H
1-54822	(54822) 1" Aluminum Packaged 2 Per Pack	\$3.95 H
1-54810	(54810) 1" Aluminum 36 Ct. Display Box	\$59.95 H
1-54844	(54844) 1" Brass Packaged Each	\$3.49 H

Boater Sports Snap Type Drain Plugs

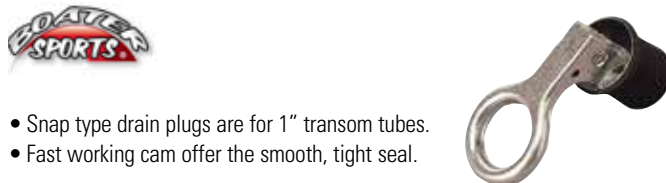

- Snap type drain plugs are for 1" transom tubes.
- Fast working cam offer the smooth, tight seal.

Order No.	Mfg. No. / Description	Price
1-54802	(54802) 1" Stainless Steel Packaged Each	\$3.95 H
1-54824	(54824) 1" Aluminum Packaged 2 Per Pack	\$3.95 H
1-54805	(54805) 1" Aluminum 36 Ct. Display Box	\$59.95 H
1-54842	(54842) 1" Brass Packaged Each	\$3.95 H
1-54843	(54843) 1-1/4" Brass Packaged Each	\$6.19 H

Moeller Snap-Tite Drain Plugs



- Corrosion resistant construction.
- Designed only for mounting from the inside of the transom.
- These plugs utilize a smooth operating mechanism to provide the tightest possible seal.

Order No.	Mfg. No. / Description	Price
486873	(290020) 1" Brass Fishbowl of 20	\$129.98 H
486945	(029000-50) 1" Brass Bucket of 48	\$184.98 F
486969	(029070-10) 1" Aluminum Sold Each	\$4.49 H
486957	(029055-001) 1-1/4" Brass Sold Bulk	\$5.98 H

Moeller Turn-Tite Drain Plugs



- Corrosion resistant construction.
- Designed only for mounting from the inside of the transom.
- Fully adjustable, simply turn the T-handle clockwise to create a waterproof construction.

Order No.	Mfg. No. / Description	Price
486872	(2089920) 1" Brass Fishbowl of 20	\$97.98 H
486868	(020899-50) 1" Brass Bucket of 48	\$150.98 F
486820	(020883-001) 1-1/4" Brass Sold Bulk	\$3.93 H

Marpac Baitwell Plugs



- Brass handle.
- Neoprene plug.
- Sold 2 per card.

Order No.	Description	Price
7-0570	Size 1/2"	\$3.79 G
7-0571	Size 5/8"	\$3.79 G
7-0572	Size 3/4"	\$3.79 G

Boater Sports Deck and Baitwell Plugs

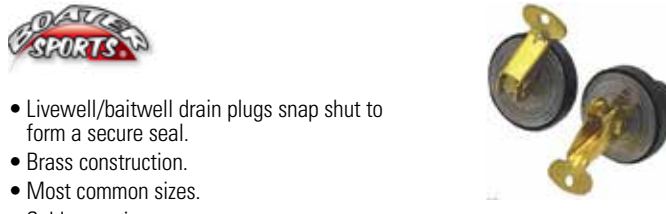

- Livewell/baitwell drain plugs snap shut to form a secure seal.
- Brass construction.
- Most common sizes.
- Sold per pair.

Order No.	Mfg. No. / Description	Price	Order No.	Mfg. No. / Description	Price
1-54847	(54847) 7/16"	\$5.12 H	1-54858	(54858) 11/16"	\$6.17 H
1-54850	(54850) 1/2"	\$4.25 H	1-54856	(54856) 3/4"	\$4.25 H
1-54854	(54854) 5/8"	\$4.25 H	1-54860	(54860) 7/8"	\$6.07 H

- Fun & Flotation
- Anchor & Dock
- Safety
- Electronics
- Trolling Motors
- Lighting
- Electrical
- Topside Acc.
- Cockpit & Deck
- Instruments
- Steering, Controls
- Perform.
- Fuel System
- Engine & Parts
- Engine Care
- Propellers
- Seating & Pedestals
- Tops & Covers
- Pumps
- Cleaning & Care
- Paint & Paint Acc.
- Hardware, Fasteners
- Trailering
- Misc.
- Comm.

- Fun & Flotation
- Anchor & Dock
- Safety
- Electronics
- Trolling Motors
- Lighting
- Electrical
- Topside Acc.
- Cockpit & Deck
- Instruments
- Steering, Controls
- Perform.
- Fuel System
- Engine & Parts
- Engine Care
- Propellers
- Seating & Pedestals
- Tops & Covers
- Pumps
- Cleaning & Care
- Paint & Paint Acc.
- Hardware, Fasteners
- Trailing
- Misc.
- Comm.

Moeller Turn-Tite Deck and Baitwell Plugs



- For use in livewells or baitwells.
- The neoprene body, stainless steel plates and adjustable brass cam snaps to provide a leakproof, nonslip seal.
- Stopper is adjustable.

Order No.	Mfg. No. / Description	Price
487000	(051001-10) 3/8" ID	\$3.40 R
487024	(051003-10) 1/2" ID	\$3.70 R
487048	(051005-10) 5/8" ID	\$3.98 R
487062	(051007-10) 3/4" ID	\$4.21 R
487086	(051009-10) 7/8" ID	\$4.14 R

Marpac Drain Plug



- Screw type construction of nylon featuring O-ring for positive seal.
- 1" diameter mounting hole.
- Black.

Order No.	Description	Price
7-0368	Drain Plug	\$5.98 G

T-H Marine Drain Plugs



- This screw-type drain plug is constructed of polypropylene and features an chemically inert O-ring for positive sealing.
- Mounts in a 1" diameter hole with two #8 countersunk stainless steel screws.
- Mounting flange is approximately 1-1/2" x 2".

Order No.	Mfg. No. / Description	Price
641389	(DP-1-DP) Black	\$7.98 H
641391	(DP-2-DP) White	\$7.98 H

Moeller Transom Drain Tube with Plug



- Fits flush to boat transom or exterior.
- The plug has a screw-driver slot and rubber O-ring to seal watertight.
- Tough natural nylon will not rot, bend or mildew.
- Fits 1-1/8" ID opening, flange OD 2-3/16".

Order No.	Mfg. No. / Description	Price
486755	(020303-10)	\$6.98 R
4810044	(20304-10) Spare Plug (5 Per Package)	\$7.98 G

Perko Fig. 714 Garboard Drain Plugs



- Cast bronze flange with brass plug.
- 1/2" IPT thread.
- Flange OD 2".
- Uses #8 fasteners.

Order No.	Mfg. No. / Description	Price
541753	(0714 DP1 PLB)	\$30.98 R
467628	(28-087) 1/2" Brass Plug, Sold Each in Bulk	\$3.98 Q

Moeller Air Chamber Plug



- Designed to seal 5/8" openings in baitwells, livewells or dry boxes.
- Oil and grease resistant.
- Just pop in the black neoprene rubber plug for a secure, tight fit.

Order No.	Mfg. No. / Description	Price
487199	(090801-10)	\$3.98 R

Marpac Automatic Drain Plug



- Automatically drains water when boat is moving.
- Provides seal when boat is stopped.
- For use with standard 1" drain installations when transoms are up to 2-1/4" thick.

Order No.	Description	Price
7-0612	Automatic Drain Plug	\$10.98 G
7-0613	Replacement Flapper Valve	\$5.98 LQ

Boater Sports Drain Plug Assembly



- This screw-type drain plug is constructed of black nylon and features an O-ring for positive sealing.
- Fine threads maintain sealing under heavy vibrations.
- Mounts in a 1" diameter hole.
- Ideal for transoms, livewells, water tanks or even ice chests.

Order No.	Mfg. No. / Description	Price
1-54838	(54838)	\$3.46 H

Marpac Garboard Drain Plugs



- Fits 1/2" NPT pipe.
- Flange OD 2".
- Depth 5/8".

Order No.	Description	Price
7-0352	Stainless Steel	\$17.98 G
7-0353	Spare Stainless Steel Plug 1 Per Card	\$11.98 G
7-0322	Cast Bronze	\$7.98 G
7-0824	Spare Cast Bronze Plug 2 Per Card	\$6.98 H

Boater Sports Garboard Drain Plug - Brass



- Garboard drain plug provides bilge drainage when hauling out.
- Machined, tapered pipe threads ensure water tight fit.
- All garboard drain plugs are 1/2" NPT male threads.

Order No.	Mfg. No. / Description	Price
1-54837	(54837) Drain and Plug, Packaged	\$10.45 H
1-54835	(54835) Easy Screw Replacement Plug	\$5.75 H
1-54836	(54836) Replacement Plug, Packaged	\$4.26 H

Marpac Flanged Drain Tube



- Brass.
- Dimensions: 1" x 3".

Order No.	Description	Price
7-0569	Flanged Drain Tube	\$4.04 G

Boater Sports Brass Drain Tube



- For use with 1" drain plugs.
- .032" wall thickness.
- Length 3".

Order No.	Mfg. No. / Description	Price
1-54832	(54832) Packaged	\$3.97 H

Moeller Drain Tubes



- Special alloy brass or aluminum tube flanged 90° on one end to function as a drain for transom, motorwell, livewell or baitwell
- Use brass tubes with brass plugs and aluminum tubes with aluminum plugs.
- Wall thickness .035".
- Measurements are OD x length.

Order No.	Mfg. No. / Description	Price
486870	(021002-188D) 1" x 1-7/8" Aluminum	\$2.44 R
486882	(021003-188D) 1" x 1-7/8" Brass	\$3.98 R
486894	(021003-300D) 1" x 3" Brass	\$6.98 I
486907	(021253-300D) 1-1/4" x 3" Brass	\$6.98 R

Moeller Flanging Tool



- For 1" drain tubes.
- Sold each per box.

Order No.	Mfg. No. / Description	Price
486781	(020700-00)	\$41.98 F

Moeller Motorwell Drain Tube



- Concentric rings snap-lock in place for a tight leakproof seal in 1" diameter opening.
- Durable plastic drain for motorwell, livewell or baitwell.
- Will not rot, bend or mildew.
- 3/4" to 2-1/2" long.

Order No.	Mfg. No. / Description	Price
486743	(020300-10)	\$3.91 R

Marpac Cockpit Scupper Valve



- Molded white plastic with soft black flapper valve.
- Uses #6 fasteners.
- 2-7/8" OD.
- Note: Fasteners not included.

Order No.	Description	Price
7-0351	Cockpit Scupper Valve	\$3.98 G

T-H Marine Flush Mount Scupper Assembly



- Designed to mount over a drain tube or to mount directly to a 1-1/2" thru hull with four screws.
- Features a "curl proof" flapper.
- Will retrofit other manufacturers' rubber flapper assemblies.
- White frame/black flapper.

Order No.	Mfg. No. / Description	Price
641868	(SA-2B-DP)	\$8.98 H

Perko Fig. 365 Scupper Valve Assembly



- For surface mount applications.
- Molded white polymer.
- Soft black flapper valve.
- Does not include thru-hull and mounting hardware.
- Uses #6 fasteners.
- 2-7/8" OD.

Order No.	Mfg. No. / Description	Price
237126	(0365 DP)	\$14.98 F

Boater Sports Cockpit Scupper Valve



- 2-3/4" diameter rubber valve mounts above the waterline, below cockpit drain level on the transom.
- Allows water to exit your boat but not enter.

Order No.	Mfg. No. / Description	Price
1-54230	(54230)	\$3.45 H

Marpac Self Bailing Scupper



- Replace worn out flapper scuppers.
- Large 1-1/8" drain allows 70% more water drainage than nearest competitor.
- Clearing debris is a snap with easy twist-off design.
- Multiple mounting holes make retrofits quick and easy - no filling holes or re-drilling.
- Neutral buoyancy ball insures ball won't float up and break seal.
- Stainless steel security pin provided for added safety.
- 3" D x 2-1/2" H.

Order No.	Description	Price
7-0232	Self Bailing Scupper	\$12.98 G

T-H Marine Flow-Max™ Ball Scupper



- Replaces worn out flapper scuppers.
- 70% more drainage than competitive models.
- Twist off for easy clearing.
- Retrofits all hole patterns.
- Stainless steel lock screw for safety.
- Seal is slotted to fit over 1-1/4" motorwell tube.
- Large 1-1/8" drain.
- 3" diameter x 2-1/2" height.

Order No.	Mfg. No. / Description	Price
247748	(FMS-1-0-DP) Clear, Bulk	\$14.98 H

- Fun & Flotation
- Anchor & Dock
- Safety
- Electronics
- Trolling Motors
- Lighting
- Electrical
- Topside Acc.
- Cockpit & Deck
- Instruments
- Steering, Controls
- Perform.
- Fuel System
- Engine & Parts
- Engine Care
- Propellers
- Seating & Pedestals
- Tops & Covers
- Pumps
- Cleaning & Care
- Paint & Paint Acc.
- Hardware, Fasteners
- Trailering
- Misc.
- Comm.

T-H Marine Inline Scupper Check Valves



- Prevents backwash.
- Chemical resistant materials.
- Thermo-plastic flapper.
- Black.

Order No.	Mfg. No. / Description	Price
247736	(ILS-750-DP) Fits 3/4" Hose	\$18.98 H
247737	(ILS-1200-DP) Fits 1-1/8" Hose	\$18.98 H
247746	(ILS-1500-DP) Fits 1-1/2" Hose	\$18.98 H

T-H Marine Recessed Threaded Thru-Hull Scupper



- Molded of a flexible thermo-plastic that is totally impervious to the effects of sun and chemicals.
- Will not curl up, rot or lose their sealing ability.
- This thru-hull type scupper is barbed to fit 1-1/2" ID hose.
- The threaded portion accommodates hulls up to 3-1/2" thick.
- Mounting nut is included.

Order No.	Mfg. No. / Description	Price
641832	(RFTH-2B-DP) White	\$18.98 H

T-H Marine Scupper Flapper Repair Kit



- Repairs most scuppers with flappers, regardless of manufacturer.
- Kit contains all parts needed to repair 2 scuppers of a given size.
- Each kit contains 2 each of: 1-5/8" flappers, 1-7/8" flappers, and 2-1/4" flappers, and all necessary keepers and fasteners.

Order No.	Mfg. No. / Description	Price
641867	(FSRK-1-DP)	\$14.98 H

T-H Marine Duck Bill Scupper



- Tough thermoplastic flapper.
- Seals tight under water pressure.
- Easy to install over drain tubes.
- Outer ring diameter is 2-3/4".
- Universal hole patter/size to replace flapper scuppers.

Order No.	Mfg. No. / Description	Price
641860	(DBS-2-DP) White	\$10.98 H

Perko Fig. 285 Flush Mount Cockpit Scupper



- Molded white polymer.
- Flush mount.
- For use when discharge is above the waterline.
- Insert prevents passage of large objects without restricting waterflow.
- Maximum hull thickness 1-3/4" for 1-1/2" hose.
- 2-3/4" OD.

Order No.	Mfg. No. / Description	Price
536777	(0285 DP)	\$21.98 R

Perko Fig. 323 Thru-Hull Scupper



- Molded white polymer.
- Soft black flapper valve.
- For mounting through transom.
- Maximum hull thickness 2-1/8" for 1-1/2" hose.
- Complete with nut and mounting hardware.
- Mounting hole diameter: 1-7/8".
- Flange OD: 2-7/8".

Order No.	Mfg. No. / Description	Price
537360	(0323 DP)	\$41.98 R

T-H Marine Floor Drain and Vent



- Designed with a flange molded into part to fit into hole so that cut or raw edges are hidden by floor drain for a more efficient, attractive installation.
- Works on fiberglass or carpeted surfaces.
- Molded black plastic.
- Mounts with 4 screws.

Order No.	Mfg. No. / Description	Price
641452	(FD-2-DP) 4-1/4" OD, Diameter Hole 2-1/2"	\$4.85 H
641464	(FD-4-DP) 5-5/8" OD, Diameter Hole 4"	\$6.98 H

T-H Marine Cockpit Scupper Drain



- This injection molded part is high strength and UV stabilized.
- Fits 1-1/2" drain hoses.
- The check ball contained inside the cockpit scupper drain is molded and then ground smooth and round to provide better sealing against reverse waterflow that occurs when backing boat.
- The overall diameter of the mounting flange is 3-9/16".
- The cockpit scupper drain requires a 2-1/2" diameter hole for installation and mounts with four #8 screws (not furnished).
- Top of cockpit scupper drain is removable for cleaning.

Order No.	Mfg. No. / Description	Price
641862	(CSD-2-DP) 45° White	\$59.98 H

- Fun & Flotation
- Anchor & Dock
- Safety
- Electronics
- Trolling Motors
- Lighting
- Electrical
- Topside Acc.
- Cockpit & Deck
- Instruments
- Steering, Controls
- Perform.
- Fuel System
- Engine & Parts
- Engine Care
- Propellers
- Seating & Pedestals
- Tops & Covers
- Pumps
- Cleaning & Care
- Paint & Paint Acc.
- Hardware, Fasteners
- Trailer
- Misc.
- Comm.

Marpac RNF Bilgeflex Hose



- Smooth, clear PVC tube with black PVC helical rod.
- Excellent flexibility and bend radius.
- For use in bilge pump discharge, livewell circulation and scupper.

Order No.	Description	Price
7-2770	3/4" x 10'	\$32.98 H
7-2775	1-1/8" x 10'	\$46.98 H

MPI Products Series 141 PVC Bilge VAC Hose



- Smooth clear vinyl tube reinforced with black PVC helix rod.
- Excellent flexibility for use as bilge pump discharge.
- Tube produced from FDA approved compound suitable for potable water.

SOLD IN 50' BOX

Order No.	Mfg. No. / Description	Price
770722	(141-0346) 3/4" Clamp (276053) 7/16" - 1-1/16"	\$76.98 H
770734	(141-1186) 1-1/8" Clamp (276079) 9/16" - 1-1/2"	\$97.98 H
770746	(141-1126) 1-1/2" Clamp (276091) 1" - 2"	\$123.98 H

SOLD IN 10' LENGTH

Order No.	Mfg. No. / Description	Price
770730	(141-1183) 1-1/8" Clamp (276079) 9/16" - 1-1/2"	\$17.98 H

MPI Products Series 164 White Reinforced PVC Tubing

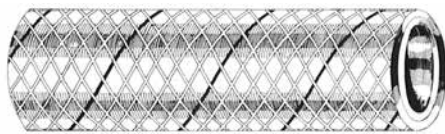

- Blue tracer.
- Heavy duty, clear vinyl cover with white inner tube reinforced for wash down, pressurized water systems, hot/cold water vent and drain lines.
- Non-toxic, odorless, tasteless and FDA approved compound.
- Operating temperature range -20° F to +150° F.
- Burst pressure 250 PSI.

SOLD IN 50' BOX

Order No.	Mfg. No. / Description	Price
770998	(164-0126) 1/2" Clamp (276053) 7/16" - 1-1/16"	\$49.98 H
771003	(164-0586) 5/8" Clamp (276053) 7/16" - 1-1/16"	\$62.98 H
771015	(164-0346) 3/4" Clamp (276053) 7/16" - 1-1/16"	\$79.98 H

Marpac RNF PVC Hose



- Heavy duty clear vinyl non-toxic reinforced tubing with red and blue tracers.
- Made with FDA approved compound.
- Excellent for use with potable water.

Order No.	Description	Price
7-2785	1/2" x 15'	\$26.98 LQ

Marpac Bilgeflex Hose



- Heavy corrugated polyethylene construction with custom molded cuff every foot for easy installation and clamping.
- Excellent flexibility.
- Ideal for electric and manual bilge pumps and livewell aerators.
- Resists heat, cold, sea water, ozone and oily bilge acids.
- Quality tested for marine applications.

Order No.	Description	Price
7-2755	3/4" x 10'	\$23.98 H
7-2760	1-1/8" x 10'	\$31.98 H

MPI Products Series 120 Standard Bilge Hose



- Heavy corrugated polyethylene hose provides outstanding flexibility.
- Resists oily bilge acids and sea water.
- Ideal for electric and manual bilge pumps and livewell aerators.
- Custom molded cuffs provide proper clamping.

SOLD IN 50' BOX

Order No.	Mfg. No. / Description	Price
770633	(120-0586) 5/8" Black	\$27.98 H
770657	(120-0346) 3/4" Black	\$29.98 H
770671	(120-1186) 1-1/8" Black	\$38.98 H
770683	(120-1146) 1-1/4" Black	\$47.98 H
770708	(120-1126) 1-1/2" Black	\$65.98 H
770645	(120-0341) 3/4" x 6' Black, Sold Per Bag	\$4.29 H
770544	(121-0346) 3/4" White	\$29.98 H
770556	(121-1186) 1-1/8" White	\$38.98 H
770568	(121-1126) 1-1/2" White	\$65.98 H

MPI Products Series 148 White Sanitation Hose

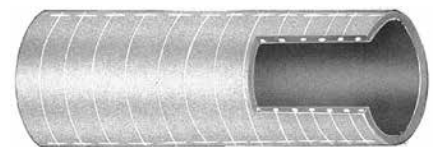

- VAC rating is 28.
- White.
- Smooth wall extra heavy duty vinyl hose for all sanitation system connections and other critical applications.
- FDA approved and low water absorption compounds provide excellent odor resistance.

SOLD IN 50' BOX

Order No.	Mfg. No. / Description	Price
771407	(148-0346) 3/4"	\$104.98 H
771419	(148-1006) 1"	\$121.98 H
771421	(148-1186) 1-1/8"	\$137.98 H
771433	(148-1146) 1-1/4"	\$157.98 H
771445	(148-1126) 1-1/2"	\$169.98 H

- Fun & Flotation
- Anchor & Dock
- Safety
- Electronics
- Trolling Motors
- Lighting
- Electrical
- Topside Acc.
- Cockpit & Deck
- Instruments
- Steering, Controls
- Perform.
- Fuel System
- Engine & Parts
- Engine Care
- Propellers
- Seating & Pedestals
- Tools & Covers
- Pumps
- Cleaning & Care
- Paint & Paint Acc.
- Hardware, Fasteners
- Trailering
- Misc.
- Comm.

MPI Products Series 150 Clear PVC Tubing



- Single extrusion, non-toxic vinyl hose produced with FDA approved compound.
- Recommended for non-pressurized cool water uses such as freshwater, sink, shower, livewell and refrigerator drain lines.
- Clear.

SOLD IN 50' BOX

Order No.	Mfg. No. / Description	Price
770760	(150-0386) 3/8" Clamp (276015) 7/32" - 5/8"	\$34.98 H
770772	(150-0126) 1/2" Clamp (276053) 7/16" - 1-1/16"	\$56.98 H
770784	(150-0586) 5/8" Clamp (276053) 7/16" - 1-1/16"	\$67.98 H
770796	(150-0346) 3/4" Clamp (276053) 7/16" - 1-1/16"	\$78.98 H
770809	(150-1006) 1" Clamp (276067) 7/16" - 1-1/4"	\$122.98 H

MPI Products Series 149 Heavy Duty PVC Livewell - Black

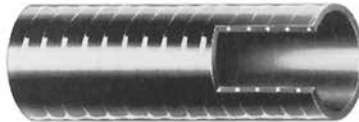

- Helical PVC reinforcement provides excellent flexibility and bend radius for heavy duty livewell and bilge pump applications.
- Smooth outer surface allows easy clamping.
- Not suitable for pressurized water systems.

SOLD IN 50' BOX

Order No.	Mfg. No. / Description	Price
771560	(149-0346) 3/4" Clamp (276053) 7/16" - 1-1/16"	\$82.98 H
771562	(149-1186) 1-1/8" Clamp (276079) 9/16" - 1-1/2"	\$107.98 H
771563	(149-1126) 1-1/2" Clamp (276091) 1" - 2"	\$172.98 H

SOLD PER FOOT

Order No.	Mfg. No. / Description	Price
7680027	(149-0340) 3/4" Clamp (276053) 7/16" - 1-1/16"	\$1.41 H

AWAB 316 Stainless Steel Hose Clamps



- Features rolled band edges to eliminate the risk of damage to the hose.
- The extra wide threads of the band are stamped, leaving the unperforated band smooth on the inside.
- Sold 10 per box.

Order No.	Mfg. No. / Description	Price
275506	(319017) SAE Size: 4 7/16" - 11/16"	\$35.98
275518	(319020) SAE Size: 6 1/2" - 13/16"	\$38.98
275520	(316024) SAE Size: 8 5/8" - 15/16"	\$37.98
275532	(316028) SAE Size: 10 3/4" - 1-1/8"	\$39.98
275544	(316032) SAE Size: 12 7/8" - 1-1/4"	\$39.98
275556	(316038) SAE Size: 16 1-1/16" - 1-1/2"	\$41.98
275568	(316044) SAE Size: 20 1-1/4" - 1-3/4"	\$42.98
275570	(316050) SAE Size: 24 1-1/2" - 2"	\$45.98
275582	(316057) SAE Size: 28 1-1/4" - 2-1/4"	\$46.98
275594	(316064) SAE Size: 32 1-1/2" - 2-1/2"	\$52.98
275619	(316076) SAE Size: 40 2" - 3"	\$57.98
275621	(316083) SAE Size: 44 2-1/4" - 3-1/4"	\$60.98
275645	(316095) SAE Size: 52 2-3/4" - 3-3/4"	\$61.98
275671	(316114) SAE Size: 64 3-1/2" - 4-1/2"	\$73.98
275695	(316140) SAE Size: 80 4" - 5-1/2"	\$81.98
275710	(316165) SAE Size: 96 5" - 6-1/2"	\$95.98

MPI Products Series 162 Clear Reinforced PVC Tubing



- Red and blue tracer.
- Heavy duty, all clear vinyl tubing reinforced for hot or cold pressurized water systems and many other uses.
- Non-toxic, odorless, tasteless and FDA approved compound.
- Operating temperature range -20° F to +150° F.
- Burst pressure 250 PSI.

SOLD IN 50' BOX

Order No.	Mfg. No. / Description	Price
770900	(162-0386) 3/8" Clamp (276015) 7/32" - 5/8"	\$42.98 H
770912	(162-0126) 1/2" Clamp (276053) 7/16" - 1-1/16"	\$59.98 H
770924	(162-0586) 5/8" Clamp (276053) 7/16" - 1-1/16"	\$66.98 H
770936	(162-0346) 3/4" Clamp (276053) 7/16" - 1-1/16"	\$86.98 H
770948	(162-1006) 1" Clamp (276067) 7/16" - 1-1/4"	\$123.98 H
770950	(162-1186) 1-1/8" Clamp (276079) 9/16" - 1-1/2"	\$145.98 H
770962	(162-1146) 1-1/4" Clamp (276089) 3/4" - 1-3/4"	\$225.98 H
770974	(162-1126) 1-1/2" Clamp (276091) 1" - 2"	\$321.98 H

MPI Products Series 132 Heavy Duty Water/Heater Hose

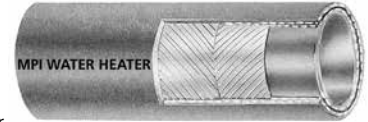

- Heavy wall EPDM tube and cover reinforced with high strength polyester yarn.
- Used mainly for engine water, water heater, bait box, air conditioner circulation and icebox, sink and shower drain lines.
- Resistance to mild chemicals, heat, cold, ozone and sea water.
- 2 ply.
- Operating temperature range -40° F to +210° F.
- Burst pressure 600#.

SOLD IN 50' BOX

Order No.	Mfg. No. / Description	Price
770607	(132-0126) 1/2" Clamp (276053) 7/16" - 1-1/16"	\$75.98 H
770619	(132-0586) 5/8" Clamp (276053) 7/16" - 1-1/16"	\$81.98 H
770621	(132-0346) 3/4" Clamp (276053) 7/16" - 1-1/16"	\$97.98 H

AWAB Hose Clamps

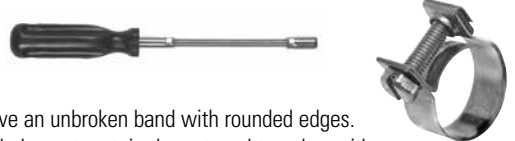

- Mini clamps have an unbroken band with rounded edges.
- The band is folded over to retain the nut, and together with the small screw-thread pitch, gives the clamp self locking characteristics.
- Sold 20 per box.

Order No.	Mfg. No. / Description	Price
275811	(306008) 19/64" - 21/64"	\$42.98
275823	(306010) 3/8" - 7/16"	\$43.98
275859	(306013) 31/64" - 35/64"	\$44.98
275861	(306014) 17/32" - 19/32"	\$45.98
275873	(306015) 37/64" - 5/8"	\$45.98
275885	(306016) 19/32" - 43/64"	\$47.98
275897	(306017) 5/8" - 45/64"	\$47.98
275900	(125010) Flexible Clamp Driver	\$24.98

AWAB Wall Merchandiser

- Includes (10) of the following hose clamps: 316017, 316020, 316024, 316028, 316032, 316038, 316044, 316050, 316057, 316064 and (1) 125010 flexible clamp driver.



Order No.	Mfg. No. / Description	Price
275924	(A316101)	\$497.98 LQ

Boater Sports Universal Hose Clamps



- Easily attach and seal a hose onto a fitting or barb.
- Stainless steel construction for a long lifetime.
- Sold 2 per package.

Order No.	Mfg. No. / Description	Price
1-57202	(57202) 1/4" - 5/8"	\$1.65 I
1-57204	(57204) 3/8" - 7/8"	\$1.60 H
1-57206	(57206) 7/16" - 1"	\$1.99 H
1-57208	(57208) 1/2" - 1-1/16"	\$2.69 H
1-57210	(57210) 5/8" - 1-1/4"	\$2.89 H
1-57212	(57212) 3/4" - 1-1/2"	\$2.25 C

Ideal Micro-Gear 62M Stainless Steel Hose Clamps



- All 300 grade stainless steel marine grade clamp.
- These clamps are tiny, tough and precision engineered for use in such small hose applications.
- Their slim 5/16" band and low profile housing makes them easy to install in confined areas.

DMI #	MFG #	Size	Clamp Diameter	Fits Hose ID	Price
276015	(62604/02)	04	1/4" - 5/8"	1/8" to 5/16"	\$0.98 I
276027	(62606MS SS)	06	5/16" - 7/8"	1/4" to 7/16"	\$0.98 I

Marpac Hose Clamp Display



- This display includes the following:
 - (10) 276015 - STE Size: 04 Clamp Diameter: 1/4" - 5/8"
 - (10) 276027 - STE Size: 06 Clamp Diameter: 5/16" - 7/8", 1/4" to 7/16"
 - (10) 276053 - STE Size: 10 Clamp Diameter: 1/2" - 1-1/16"
 - (10) 276079 - STE Size: 16 Clamp Diameter: 9/16" - 1-1/2"
 - (10) 276089 - STE Size: 20 Clamp Diameter: 3/4" - 1-3/4"
 - (10) 276091 - STE Size: 24 Clamp Diameter: 1" - 2"
 - (10) 276128 - STE Size: 36 Clamp Diameter: 7/8" - 2-3/4"
 - (10) 276142 - STE Size: 48 Clamp Diameter: 1-5/8" - 3-1/2"

Order No.	Description	Price
7-3005	Hose Clamp Display	\$156.98 G

2 Ear Crimp Hose Clamp



- Stainless steel.
- Nominal size 3/4".
- Width .335".
- Closed/open .669/.787".

Order No.	Mfg. No. / Description	Price
645768	(4E589)	\$4.16 B

Ideal 9/16" Hy-Gear® Stainless Steel Hose Clamps



- 300 grade stainless steel.
- High nickel alloy stainless steel meets the demands of inground and marine use.
- A marine grade clamp for boating applications and other corrosive environments.
- Band and housing: 9/16" wide.
- Sold box of 10.

DMI #	Mfg. No.	Size	Min. (in.)	Max. (in.)	Min. (mm)	Max. (mm)	Price
276039	(630040006051)	06	3/8"	7/8"	10	22	\$1.40 I
276041	(630040008051)	08	7/16"	1"	11	25	\$1.40 I
276053	(630040010051)	10	1/2"	1-1/16"	13	27	\$1.40 I
276067	(630040012051)	12	1/2"	1-1/4"	13	32	\$1.43 I
276079	(630040016051)	16	11/16"	1-1/2"	18	38	\$1.43 I
276089	(630040020051)	20	3/4"	1-3/4"	19	44	\$1.48 I
276091	(630040024051)	24	1"	2"	25	51	\$1.48 I
276104	(630040028051)	28	1-1/4"	2-1/4"	32	57	\$1.48 I
276116	(630040032051)	32	1-1/2"	2-1/2"	38	63	\$1.48 I
276128	(630040036051)	36	3/4"	2-3/4"	19	70	\$1.52 I
276130	(630040040051)	40	1"	3"	26	76	\$1.64 I
276134	(630040044051)	44	1-1/4"	3-1/4"	32	83	\$1.89 I
276142	(630040048051)	48	1-1/2"	3-1/2"	38	89	\$1.89 I
276146	(630040052051)	52	1-3/4"	3-3/4"	44	95	\$1.98 I
276154	(630040056051)	56	2"	4"	51	101	\$1.98 I
276166	(630040064051)	64	2-1/2"	4-1/2"	64	114	\$2.19 I
276178	(630040072051)	72	3"	5"	76	127	\$2.29 I
276180	(630040080051)	80	3-1/2"	5-1/2"	89	140	\$2.50 I
276192	(630040088051)	88	4"	6"	102	152	\$2.55 I
276205	(630040096051)	96	4-1/2"	6-1/2"	114	165	\$2.64 I
276217	(630040104051)	104	5"	7"	127	178	\$2.67 I

Ideal Hose Clamp Display



- Yellow, plastic counter top display with 120 stainless steel hose clamps.
- The display includes: (20) 62602, (10) 62606, (10) 6310, (20) 6312, (30) 6320, (20) 6328 and (10) 6336 clamps.

Order No.	Mfg. No. / Description	Price
276003	(6304MS)	\$395.98 LQ

- Fun & Flotation
- Anchor & Dock
- Safety
- Electronics
- Trolling Motors
- Lighting
- Electrical
- Topside Acc.
- Cockpit & Deck
- Instruments
- Steering, Controls
- Perform.
- Fuel System
- Engine & Parts
- Engine Care
- Propellers
- Seating & Pedestals
- Tops & Covers
- Pumps
- Cleaning & Care
- Paint & Paint Acc.
- Hardware, Fasteners
- Trailering
- Misc.
- Comm.

T-H Marine Stainless Steel Oetiker® Stepless Ear Hose Clamps



- Stainless steel.
- Forms a full 360° circle.
- Tongue and groove interlock design.
- Fast clamping with tool.
- No leaks around hose.

Order No.	Mfg. No. / Description	Quantity	Price
247805	(16700001) 5.8 - 7.0 mm	100 Per Bag	\$61.98 H
247808	(16700004) 7.8 - 9.5 mm	100 Per Bag	\$61.98 H
247810	(16700006) 8.8 - 10.5 mm (3/8")	100 Per Bag	\$61.98 H
247818	(16700011) 11.0 - 13.8 mm (1/2")	100 Per Bag	\$61.98 H
247821	(16700017) 14.5 - 17.0 mm (5/8")	100 Per Bag	\$64.98 H
247829	(16700024) 17.8 - 21.0 mm (3/4")	100 Per Bag	\$76.98 H
247836	(16700031) 22.4 - 25.6 mm (1")	100 Per Bag	\$79.98 H
247842	(16705000) 34.9 - 38.1 mm (1-1/2")	100 Per Bag	\$91.98 H

T-H Marine Oetiker® Stepless Ear Clamp Kit



- Great for shop or rigging work.
- Contains 10 each of the most needed sizes.
- Complete with connection tool.

Order No.	Mfg. No. / Description	Price
642656	(18500000)	\$183.98 H

Sierra Oetiker Hose Clamps



- Size is for outside diameter of hose.
- Sold 10 per package.

Order No.	Mfg. No. / Description	Quantity	Price
1891269	(18-9126-9) Hose OD 3/8"	9.5 mm	\$13.37 H
1891279	(18-9127-9) Hose OD 13/32"	10.5 mm	\$12.01 H
1891289	(18-9128-9) Hose OD 7/16"	11.3 mm	\$13.75 H
1891299	(18-9129-9) Hose OD 1/2"	13.3 mm	\$14.69 H
1891319	(18-9131-9) Hose OD 35/64"	14 mm	\$13.87 H
1891329	(18-9132-9) Hose OD 9/16"	14.5 mm	\$13.87 H
1891359	(18-9135-9) Hose OD 13/16"	21 mm	\$14.41 H
1891369	(18-9136-9) Hose OD 1"	25.6 mm	\$27.00 H
1891379	(18-9137-9) Hose OD 1-3/16"	30.1 mm	\$14.88 H
1891389	(18-9138-9) Hose OD 1-1/4"	31.6 mm	\$15.12 H
1891399	(18-9139-9) Hose OD 1-5/8"	41 mm	\$28.86 H
1891409	(18-9140-9) Hose OD 22/32"	18.5 mm	\$16.80 H

Conversion Table - Pipe Size OD (Outside Diameter) to Hose Size ID (Inside Diameter)

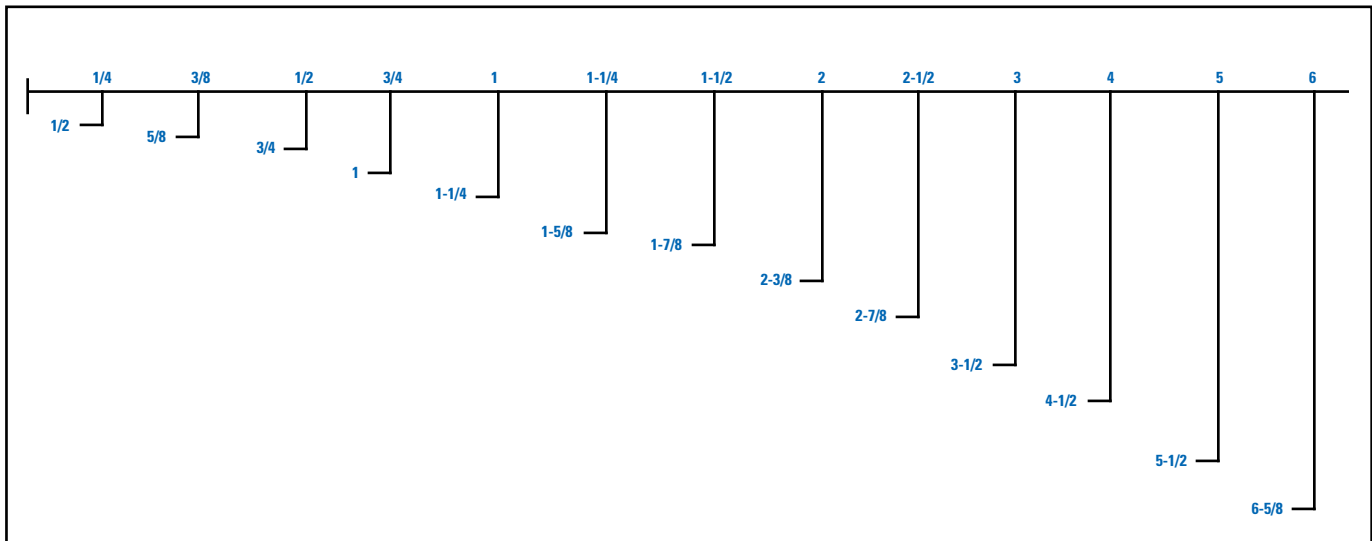

- Fun & Flotation
- Anchor & Dock
- Safety
- Electronics
- Trolling Motors
- Lighting
- Electrical
- Topside Acc.
- Cockpit & Deck
- Instruments
- Steering, Controls
- Perform.
- Fuel System
- Engine & Parts
- Engine Care
- Propellers
- Seating & Pedestals
- Tops & Covers
- Pumps
- Cleaning & Care
- Paint & Paint Acc.
- Hardware, Fasteners
- Trailer
- Misc.
- Comm.

Bronze Pipe Reducing Couplings



Order No.	Description	Price
467414	3/8" x 1/4" NPT	\$6.98 Q
467438	1/2" x 3/8" NPT	\$8.98 Q
467440	3/4" x 1/2" NPT	\$11.98 Q
467452	1" x 3/4" NPT	\$19.98 Q
467464	1-1/4" x 1" NPT	\$31.98 Q
467476	1-1/2" x 1-1/4" NPT	\$40.98 Q
467478	2" x 1-1/2" NPT	\$60.98 Q

Bronze 90° Pipe Street Elbows



Order No.	Description	Price
467250	1/4" NPT	\$8.98 H
467262	3/8" NPT	\$8.98 H
467274	1/2" NPT	\$11.98 H
467286	3/4" NPT	\$16.98 H
467298	1" NPT	\$26.98 H
467301	1-1/4" NPT	\$41.98 H
467313	1-1/2" NPT	\$53.98 H
467315	2" NPT	\$89.98 H

Bronze 45° Pipe Elbow



Order No.	Description	Price
467205	3/4" NPT	\$12.98 Q

Bronze Pipe Bushings



Order No.	Description	Price
467488	1/4" x 1/8" NPT	\$2.08 Q
467490	3/8" x 1/8" NPT	\$3.33 Q
467515	3/8" x 1/4" NPT	\$3.47 Q
467527	1/2" x 1/4" NPT	\$4.67 Q
467539	1/2" x 3/8" NPT	\$3.54 Q
467540	3/4" x 1/4" NPT	\$7.98 Q
467541	3/4" x 1/2" NPT	\$6.98 Q
467542	3/4" x 3/8" NPT	\$6.98 Q
467560	1" x 1/2" NPT	\$9.98 Q
467565	1" x 3/4" NPT	\$9.98 Q
467577	1-1/4" x 3/4" NPT	\$16.98 Q
467589	1-1/4" x 1" NPT	\$16.98 Q
467568	1-1/2" x 1" NPT	\$22.98 Q
467503	1-1/2" x 1-1/4" NPT	\$21.98 Q
467573	2" x 1-1/4" NPT	\$32.98 Q
467590	2" x 1-1/2" NPT	\$32.98 Q

Bronze 90° Pipe Elbows



Order No.	Description	Price
467096	1/4" NPT	\$5.98 Q
467109	3/8" NPT	\$5.98 Q
467111	1/2" NPT	\$8.98 Q
467123	3/4" NPT	\$12.98 Q
467135	1" NPT	\$18.98 Q
467147	1-1/4" NPT	\$29.98 Q
467159	1-1/2" NPT	\$38.98 Q
467160	2" NPT	\$61.98 Q

Bronze Pipe Plugs



Order No.	Description	Price
467591	1/8" NPT	\$1.48 Q
467604	1/4" NPT	\$2.28 Q
467616	3/8" NPT	\$3.57 Q
467628	1/2" NPT	\$3.98 Q
467630	3/4" NPT	\$7.98 Q
467642	1" NPT	\$9.98 Q

Bronze Pipe Locknuts



Order No.	Description	Price
467767	1/4" NPT	\$3.98 LQ
467806	1" NPT	\$10.98 Q
467807	1-1/4" NPT	\$17.98 Q
467820	1-1/2" NPT	\$21.98 Q

Bronze Pipe Nipples



Order No.	Description	Price	Order No.	Description	Price
466640	1/8" NPT, Close	\$4.48 H	466831	3/4" NPT, Length 1-1/2"	\$10.98 H
466652	1/8" NPT, Length 2"	\$5.98 H	466842	3/4" NPT, Length 2"	\$11.98 H
466688	1/4" NPT, Close	\$4.99 H	466854	3/4" NPT, Length 3"	\$16.98 H
466689	1/4" NPT, Length 1-1/2"	\$5.98 H	466866	3/4" NPT, Length 4"	\$21.98 H
466690	1/4" NPT, Length 2"	\$6.98 H	466880	1" NPT, Close	\$15.98 H
466693	1/4" NPT, Length 3"	\$8.98 H	466892	1" NPT, Length 2"	\$18.98 H
466727	3/8" NPT, Close	\$5.98 H	466905	1" NPT, Length 3"	\$23.98 H
466739	3/8" NPT, Length 1-1/2"	\$6.98 H	466917	1" NPT, Length 4"	\$31.98 H
466741	3/8" NPT, Length 2"	\$7.98 H	466931	1-1/4" NPT, Close	\$21.98 H
466791	1/2" NPT, Close	\$6.98 H	466936	1-1/4" NPT, Length 2"	\$24.98 H
466792	1/2" NPT, Length 1-1/2"	\$8.98 H	466993	1-1/2" NPT, Close	\$27.98 H
466804	1/2" NPT, Length 2"	\$9.98 H	467008	1-1/2" NPT, Length 2"	\$31.98 H
466806	1/2" NPT, Length 3"	\$12.98 H	467011	1-1/2" NPT, Length 3"	\$41.98 H
466830	3/4" NPT, Close	\$10.98 H	467042	2" NPT, Close	\$42.98 H

Bronze Pipe Tees



Order No.	Description	Price
467856	1/4" NPT	\$8.98 Q
467868	3/8" NPT	\$8.98 Q
467870	1/2" NPT	\$10.98 Q
467882	3/4" NPT	\$14.98 Q
467894	1" NPT	\$26.98 Q
467907	1-1/4" NPT	\$38.98 Q
467919	1-1/2" NPT	\$53.98 Q
467921	2" NPT	\$84.98 Q

Bronze Pipe Couplings



Order No.	Description	Price
467337	1/4" NPT	\$5.98 Q
467349	3/8" NPT	\$5.98 Q
467351	1/2" NPT	\$7.98 Q
467363	3/4" NPT	\$9.98 Q
467375	1" NPT	\$14.98 Q
467387	1-1/4" NPT	\$23.98 Q
467389	1-1/2" NPT	\$31.98 Q

Bronze Pipe Caps



Order No.	Description	Price
467705	1/2" NPT	\$6.98 Q
467717	3/4" NPT	\$8.98 Q
467738	2" NPT	\$43.98 Q

Fun & Flotation

Anchor & Dock

Safety

Electronics

Trolling Motors

Lighting

Electrical

Topside Acc.

Cockpit & Deck

Instruments

Steering, Controls

Perform.

Fuel System

Engine & Parts

Engine Care

Propellers

Seating & Pedestals

Tops & Covers

Pumps

Cleaning & Care

Paint & Paint Acc.

Hardware, Fasteners

Trailerling

Misc.

Comm.

Groco PTH - Straight Standard Flow Bronze Pipe to Hose Fittings

GROCO.

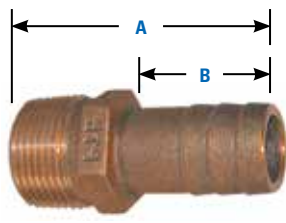

Order No.	Mfg. No.	Thread NPT	Hose ID	A	B	Price
371207	(PTH-5062)	1/2"	1/2" or 5/8"	2.70"	1.80"	\$6.98 H
542046	(PTH750)	3/4"	3/4"	2.39"	1.38"	\$8.98 G
542058	(PTH1000)	1"	1"	2.48"	1.38"	\$10.98 G
542060	(PTH1250)	1-1/4"	1-1/4"	2.65"	1.55"	\$19.98 G
542072	(PTH1500)	1-1/2"	1-1/2"	3.00"	1.90"	\$24.98 G
542084	(PTH2000)	2"	2"	3.00"	1.90"	\$34.98 G
S/O	(PTH-2500)	2-1/2"	2-1/2"	4.00"	2.00"	POR
S/O	(PTH-3000)	3"	3"	4.00"	2.00"	POR
S/O	(PTH-4000)	4"	4"	4.25"	2.00"	POR
S/O	(PTH-5000)	5"	5"	4.25"	2.00"	POR

Groco FF - Straight Full Flow Bronze Pipe to Hose Fittings

GROCO.

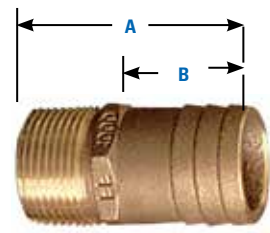

- Enough barb area for double hose clamps.
- Full pipe size flow provides an unrestricted passage through the fitting.
- Generous hex nut cast in for secure tightening.

Order No.	Mfg. No.	Thread NPT	Hose ID	A	B	Price
371219	(FF-750)	3/4"	1"	2.39"	1.38"	\$10.98 H
371221	(FF-1000)	1"	1-1/4"	2.48"	1.38"	\$14.98 H
371233	(FF-1250)	1-1/4"	1-1/2"	2.65"	1.55"	\$22.98 H
371245	(FF-1500)	1-1/2"	1-3/4"	3.00"	1.90"	\$26.98 H
371257	(FF-2000)	2"	2-1/4"	2.89"	1.75"	\$53.98 H
S/O	(FF-2500)	2-1/2"	2-3/4"	3.47"	2.00"	POR
S/O	(FF-3000)	3"	3-1/2"	3.61"	2.00"	POR

Buck Algonquin "Tuff-Lite" Nylon Hose Adapter



- Nylon.
- Hexed for easy installation.
- 1-1/2" NPT, hose 1-1/2" ID.
- Overall length 2-3/4".

Order No.	Mfg. No. / Description	Price
354679	(60TN200)	\$6.98 F

Forespar Tailpipes



- Molded in high strength glass reinforced "Marelon" for superior corrosion protection.
- Pipe to assorted hose sizes.

Order No.	Mfg. No. / Description	Price
354427	(910148) 1/4" Thread Tube ID 3/8"	\$3.74
354439	(910149) 1/4" Thread Tube ID 1/2"	\$3.28 LQ
354453	(910154) 3/8" Thread Tube ID 1/2"	\$5.98
354465	(910156) 1/2" Thread Tube ID 1/2"	\$6.98
354477	(910157) 1/2" Thread Tube ID 3/4"	\$6.98
354489	(910158) 3/4" Thread Tube ID 1/2"	\$7.98
354491	(910159) 3/4" Thread Tube ID 3/4"	\$7.98
354504	(910160) 3/4" Thread Tube ID 1"	\$9.98
354516	(910168) 1-1/4" Thread Tube ID 1-1/2"	\$11.98

Groco PTHC - 90° Standard Flow Bronze Pipe to Hose Fittings

GROCO.

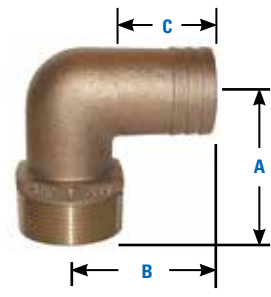

Order No.	Mfg. No.	Thread NPT	Hose ID	A	B	C	Price
541323	(PTHC750)	3/4"	3/4"	1.86"	2.05"	1.43"	\$12.98 G
541335	(PTHC1000)	1"	1"	2.34"	2.40"	1.63"	\$18.98 G
541347	(PTHC1125)	1-1/4"	1-1/8"	2.37"	2.44"	1.75"	\$25.98 G
541359	(PTHC1500)	1-1/2"	1-1/2"	2.50"	2.50"	2.25"	\$37.98 G
S/O	(PTHC-2000)	2"	2"	2.88"	3.10"	2.25"	POR
S/O	(PTHC-2500)	2-1/2"	2-1/2"	3.83"	3.35"	2.10"	POR
S/O	(PTHC-3000)	3"	3"	4.20"	3.55"	2.00"	POR
S/O	(PTHC-4000)	4"	4"	5.05"	5.25"	2.85"	POR
S/O	(PTHC-5000)	5"	5"	5.50"	6.20"	3.30"	POR

Groco FFC - 90° Full Flow Bronze Pipe to Hose Fittings

GROCO.

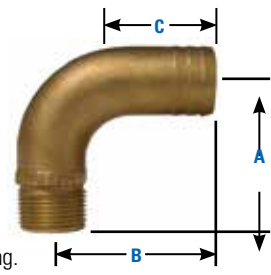

- Enough barb area for double hose clamps.
- Full pipe size flow provides an unrestricted passage through the fitting.
- Generous hex nut cast in for secure tightening.

Order No.	Mfg. No.	Thread NPT	Hose ID	A	B	C	Price
371269	(FFC-750)	3/4"	1"	2.00"	2.20"	1.45"	\$20.98 H
371271	(FFC-1000)	1"	1-1/4"	2.70"	3.00"	1.63"	\$29.98 H
371283	(FFC-1250)	1-1/4"	1-1/2"	3.60"	3.43"	1.38"	\$44.98 H
371295	(FFC-1500)	1-1/2"	1-3/4"	4.25"	4.40"	1.78"	\$54.98 H
371308	(FFC-2000)	2"	2-1/4"	5.40"	5.15"	1.85"	\$120.98 H
S/O	(FFC-2500)	2-1/2"	2-3/4"	6.55"	6.00"	2.00"	POR
S/O	(FFC-3000)	3"	3-1/2"	8.25"	6.93"	2.10"	POR

Forespar 90° Elbows



- Molded in high strength glass reinforced "Marelon" for superior corrosion protection.

Order No.	Mfg. No. / Description	Price
354263	(901000) 1/2" IPT Hose ID 5/8"	\$3.91 G
354275	(901001) 3/4" IPT Hose ID 3/4"	\$5.98 G
354287	(901002) 1" IPT Hose ID 1"	\$6.98 G
354299	(901003) 1-1/4" IPT Hose ID 1-1/4"	\$7.98 G
354302	(901004) 1-1/2" IPT Hose ID 1-1/2"	\$10.98 F

Forespar Tailpipes



- Molded in high strength glass reinforced "Marelon" for superior corrosion protection.
- Perfect choice for joining hose lines to ball valves and seacocks.

Order No.	Mfg. No. / Description	Price
354201	(905006) 1/2" NPT Hose ID 5/8"	\$4.79 G
354213	(905007) 3/4" NPT Hose ID 3/4"	\$4.79 G
354225	(905008) 1" NPT Hose ID 1"	\$8.98 G
354237	(905009) 1-1/4" NPT Hose ID 1-1/4"	\$8.98 G
354249	(905010) 1-1/2" NPT Hose ID 1-7/16"	\$8.98 G

Marpac Stainless Steel Ball Valves



- 316 investment cast stainless steel.
- Bonding screw hole included.
- Tested to 1000 psi WOG. NPT threading.



Order No.	Description	Price
7-2240	3/4"	\$59.98 G
7-2241	1"	\$74.98 G
7-2244	2"	\$315.98 G

SPARE STAINLESS STEEL LEVERS

Order No.	Mfg. No. / Description	Price
313089	(W565700) 3/4" to 1"	\$11.98 LQ
313091	(W565800) 1-1/4"	\$11.98 LQ



Groco 2-Port Fuel Valves



- Patented selectable handle rotation.
- Full flow.
- Mount foot included.
- Stainless steel handle and hardware.
- 400 WOG.
- PTFE seats and seals.
- UL Listed for fuel.



Order No.	Mfg. No. / Description	Price
Special Order	(FV-250) 1/4" NPT	Price on Request
Special Order	(FV-375) 3/8" NPT	Price on Request
Special Order	(FV-500) 1/2" NPT	Price on Request
Special Order	(FV-750) 3/4" NPT	Price on Request

Forespar Ball Valves



- Molded in high strength glass reinforced "Marelon".
- Ideal for controlling water requirements above or below the waterline.
- P.T.F.E. seals are supplied.



Order No.	Mfg. No. / Description	Price
354124	(905100) 1/2" NPT	\$45.98 F
354136	(905101) 3/4" NPT	\$46.98 F
354150	(905103) 1-1/4" NPT	\$117.98 F
354162	(905104) 1-1/2" NPT	\$137.98 F

Groco Three-Way Valve



- Ideal for waste systems.
- Full flow.
- Valve operates logically - the handle points to the direction of flow.
- Center position is "off".
- Handles rotates a full 180°.
- Mount foot included.
- Stainless steel handle and hardware. PTFE seats and seals.
- UL Listed for fuel.



Order No.	Mfg. No. / Description	Price
Special Order	(TWV-1500) 1-1/2" NPT	Price on Request

Groco Bronze Full Flow Inline Ball Valves



- 1-1/4" sizes and larger include a grease zerk fitting for lubrication (use only with the valve in the open position) or for draining.
- Patented selectable handle rotation.
- Handle has square hole to accept standard ratchet, to help reach valves in hard-to-reach locations and ease actuation of difficult to operate valves.
- 400 WOG rated.
- Full flow.
- Stainless steel handle and hardware.
- Chrome plated solid brass ball (not a hollow ball).
- PTFE seats and seals.
- Bonding attachment. UL listed for fuel or water.



Order No.	Mfg. No. / Description	Price
313003	(IBV-375) 3/8" NPT	\$16.98 Q
375231	(IBV-500) 1/2" NPT	\$22.98 G
375242	(IBV-750) 3/4" NPT	\$33.98 G
375258	(IBV-1000) 1" NPT	\$59.98 G
375268	(IBV-1250) 1-1/4" NPT	\$80.98 G
375278	(IBV-1500) 1-1/2" NPT	\$92.98 G
375281	(IBV-2000) 2" NPT	\$148.98 G

Groco Full Flow Flanged Ball Valves



- Includes one grease zerk fitting for lubrication (use only with the valve in the open position), and one drain plug. The zerk can also be used for draining.
- Patented field reversible handle allows you to select the closed position orientation (clockwise or counter-clockwise) that best suits the installation.
- Handle has square hole to accept standard ratchet, to help reach valves in hard-to-reach locations and ease actuation of difficult to operate valves.
- Full flow.
- Triangular base with bolt pattern to match most popular brands makes retrofit easy.
- Stainless steel handle and hardware. Chrome plated solid brass ball.
- PTFE seats and seals.
- Bonding attachment on base.



Order No.	Mfg. No.	Bottom Connection	Top Connection	Price
312950	(FBV-750)	3/4" NPS	3/4" NPT	\$56.98 Q
312962	(FBV-1000)	1" NPS	1" NPT	\$78.98 Q
312974	(FBV-1250)	1-1/4" NPS	1-1/4" NPT	\$96.98 Q
312986	(FBV-1500)	1-1/2" NPS	1-1/2" NPT	\$130.98 Q
312998	(FBV-2000)	2" NPS	2" NPT	\$213.98 Q

Groco 6-Port Fuel Valves



- Six-port fuel valves are used where 2 tanks supply a single engine, and a return to each supply tank is required.
- ABYC H33.9.2 states that fuel system valves must have an independent means of support, so in-line valves are not suitable for fuel system applications.
- Has a "L" shaped flow pattern and 180° handle swing.

Order No.	Mfg. No. / Description	Price
Special Order	(FV-65038) Main 1/2" NPT Return 3/8" NPT	POR
Special Order	(FV-61075) Main 1" NPT Return 3/4" NPT	POR



- Fun & Flotation
- Anchor & Dock
- Safety
- Electronics
- Trolling Motors
- Lighting
- Electrical
- Topside Acc.
- Cockpit & Deck
- Instruments
- Steering, Controls
- Perform.
- Fuel System
- Engine & Parts
- Engine Care
- Propellers
- Seating & Pedestals
- Tops & Covers
- Pumps**
- Cleaning & Care
- Paint & Paint Acc.
- Hardware, Fasteners
- Trailering
- Misc.
- Comm.

- Fun & Flotation
- Anchor & Dock
- Safety
- Electronics
- Trolling Motors
- Lighting
- Electrical
- Topside Acc.
- Cockpit & Deck
- Instruments
- Steering, Controls
- Perform.
- Fuel System
- Engine & Parts
- Engine Care
- Propellers
- Seating & Pedestals
- Tops & Covers
- Pumps
- Cleaning & Care
- Paint & Paint Acc.
- Hardware, Fasteners
- Trailer
- Misc.
- Comm.

Groco Tank Selector Valve

GROCO.



- For fuel or water.
- Four positions: Tank-1, Tank-2, Tanks 1 and 2, Off.
- Full 1/2" flow.
- Audible "click" at each handle position.
- For thru panel mounting.

Order No.	Mfg. No. / Description	Price
Special Order	(FV-450-X)	Price on Request

Groco CV Series - Check Valves

GROCO.



- CV Series in-line check valve may be used in water or fuel systems to keep pumps primed and to prevent back-flow in pressure systems.
- Unique design reduces flow turbulence and restriction, and improves pump performance.
- Cast bronze construction.
- NPT threaded ports.

Order No.	Mfg. No. / Description	Price
Special Order	(CV-50) 1/2" NPT	Price on Request
Special Order	(CV-75) 3/4" NPT	Price on Request
Special Order	(CV-100) 1" NPT	Price on Request
Special Order	(CV-125) 1-1/4" NPT	Price on Request
Special Order	(CV-150) 1-1/2" NPT	Price on Request
Special Order	(CV-200) 2" NPT	Price on Request

Marpac Stainless Steel Thru-Hull Connectors



- Stainless steel.
- Includes stainless steel nut.

Order No.	Description	Price
7-0855	Hose ID 3/4" Flange OD 1-3/4" Overall Length 3-3/4"	\$22.98 G
7-0856	Hose ID 1-1/8" Flange OD 2-1/4" Overall Length 4"	\$27.98 G
7-0857	Hose ID 1-1/2" Flange OD 3" Overall Length 4-1/4"	\$39.98 G

Groco Thru-Hull Connectors

GROCO.



- Cast bronze.
- Flange is machined to fit hull and grooved to retain bedding compound.
- Neck is threaded to approximately 3/8" from flange.

Order No.	Mfg. No. / Description	Price
256443	(TH500W) Pipe 1/2" Flange OD 1.70"	\$16.98 F
256455	(TH750W) Pipe 3/4" Flange OD 1.90"	\$18.98 F
256479	(TH1000W) Pipe 1" Flange OD 2.32"	\$26.98 F
256493	(TH1250W) Pipe 1-1/4" Flange OD 2.62"	\$47.98 F
256506	(TH1500W) Pipe 1-1/2" Flange OD 2.89"	\$69.98 F
256518	(TH2000W) Pipe 2" Flange OD 3.33"	\$92.98 Q
256520	(0322 010 PLB) Pipe 2-1/2" Flange OD 4-1/2"	\$148.98 I
256532	(0322 011 PLB) Pipe 3" Flange OD 5"	\$268.98 I

Groco 90° Fuel Valves

GROCO.



- Compact design.
- 90° flow path.
- 1/2" NPT male and female ports.

FOR FIBERGLASS TANKS

Order No.	Mfg. No. / Description	Price
Special Order	(FV-590)	Price on Request

FOR ALUMINUM & STAINLESS STEEL TANKS

Order No.	Mfg. No. / Description	Price
Special Order	(FV-590-S)	Price on Request

Brass Gate Valves



- Full port design for a better water flow.
- Screw-in bonnet - non-rising stem - solid wedge.
- Cast iron handle.
- Good for diesel fuel.

Order No.	Mfg. No. / Description	Price
485501	(940-133) 3/4" NPT	\$19.98 F
485513	(940-134) 1" NPT	\$27.98 F
485525	(940-135) 1-1/4" NPT	\$48.98 F
485537	(940-136) 1-1/2" NPT	\$61.98 F

Swing Check Valves



- Swing type disc.
- Screwed cap.
- Hard seat.
- 90° straight pattern.
- Used to prevent reverse flow in commercial and industrial applications.
- Integral seat.

Order No.	Mfg. No. / Description	Price
485561	(940-352) 1/2" NPT	\$16.98 F
485573	(940-353) 3/4" NPT	\$18.98 F
485585	(940-354) 1" NPT	\$26.98 F

Groco Extra-Length Thru-Hull Connectors

GROCO.



- Cast bronze.
- Extra length.
- For installations where hull thickness dictates the use of a longer fitting.
- Flange is machined to fit hull and grooved to retain bedding compound.
- Neck is threaded to approximately 3/8" from flange.

Order No.	Mfg. No. / Description	Price
256557	(THXL750W) Pipe 3/4" Flange OD 1.90" Max. Hull Thickness 5.33"	\$29.98 Q
256568	(THXL1000W) Pipe 1" Flange OD 2.32" Max. Hull Thickness 5.33"	\$39.98 Q
256571	(THXL1250W) Pipe 1-1/4" Flange OD 2.62" Max. Hull Thickness 5.45"	\$58.98 Q
256583	(THXL1500W) Pipe 1-1/2" Flange OD 2.89" Max. Hull Thickness 5.45"	\$70.98 Q
256595	(THXL2000W) Pipe 2" Flange OD 3.34" Max. Hull Thickness 5.58"	\$87.98 Q

Marpac 90° Thru-Hull Connectors



- High quality UV and chemical resistant engineered resin.
- Includes pass-around nut for easier installation.
- Note: These thru-hulls for hose are not recommended for use below the waterline.

FITS 3/4" HOSE. THREAD LENGTH 1"

- Flange size: 1-1/2", overall length: 2-1/2", shaft diameter 1".

Order No.	Description	Price
7-0362	White	\$6.98 G
7-0366	Black	\$5.98 G

FITS 1-1/8" HOSE. THREAD LENGTH 1-1/8"

- Flange size: 1-7/8", overall length: 3-1/2", shaft diameter 1-3/8".

Order No.	Description	Price
7-0364	White	\$7.98 G
7-0367	Black	\$7.98 G

Attwood 90° Thru-Hull Connector



- Polypropylene construction.
- Ideal for tight installations, such as livewell overflow drains.
- Fits 1-1/8" to 1-1/4" ID hose.
- Maximum hull thickness: 1-7/8".
- Flange diameter: 2-7/16". Installation hole size: 1-5/16".
- Caution: Thru-Hull connectors are designed for installation above the water line only.



Order No.	Mfg. No. / Description	Price
2350060	(3879-3) White	\$13.98 LQ

Marpac Thru-Hull Connectors



- Molded plastic.
- Note: These thru-hulls for hose are not recommended for use below the waterline.

WHITE

Order No.	Description	Price
7-0357	Hose ID 1/2" Flange OD 1-1/2" Overall Length 1-1/4"	\$4.20 G
7-0358	Hose ID 5/8" Flange OD 1-1/2" Overall Length 1-1/4"	\$4.09 G
7-0359	Hose ID 3/4" Flange OD 1-7/8" Overall Length 1-7/16"	\$4.09 G
7-0360	Hose ID 1" Flange OD 2-1/4" Overall Length 1-1/2"	\$5.98 G
7-0363	Hose ID 1-1/8" Flange OD 2-1/4" Overall Length 1-1/2"	\$5.98 G
7-0365	Hose ID 1-1/2" Flange OD 3" Overall Length 1-7/8"	\$6.98 G

BLACK

Order No.	Description	Price
7-0354	Hose ID 3/4" Flange OD 1-1/2" Overall Length 3-1/16"	\$4.33 G
7-0356	Hose ID 1-1/8" Flange OD 1-7/8" Overall Length 3-1/2"	\$4.90 G

T-H Marine 90° Thru-Hull Connector



- Our standard 90° fittings feature a unique finished head and a pass-around nut for easier and more attractive installation.

FITS 3/4" HOSE. THREAD LENGTH 1"

- Flange size: 1-1/2", overall length: 2-1/2", shaft diameter 1".

Order No.	Mfg. No. / Description	Price
6400332	(TH-7592-B) White	\$2.97 H

FITS 1-1/2" HOSE. THREAD LENGTH 1-5/8"

- Flange size: 2-7/8", overall length: 4-1/4", shaft diameter 2".

Order No.	Mfg. No. / Description	Price
642192	(TH-1592-DP)	\$12.98 H

Marpac Thru-Hull Connectors



- All nylon thru-hull with stainless steel outside cover.
- Note: These thru-hulls for hose are not recommended for use below the waterline.

Order No.	Description	Price
7-0848	Hose ID 3/4"	\$7.98 H
7-0850	Hose ID 1-1/8"	\$9.98 G
7-0852	Hose ID 1-1/2"	\$12.98 G

T-H Marine Plastic Thru-Hull Connectors



- Made of the highest quality virgin material to insure consistent size and extra durability.

HOSE ID 3/4". LENGTH 3-1/16"

- Maximum hull thickness: 1-3/4". Flange diameter: 1-1/2".

Order No.	Mfg. No. / Description	Price
640980	(TH-750-DP) Black	\$3.77 H
6400324	(TH-752-B) White	\$2.11 H

HOSE ID 1-1/2". LENGTH 3-1/2"

- Maximum hull thickness: 1-3/4". Flange diameter: 2-7/8".

Order No.	Mfg. No. / Description	Price
641414	(TH1502-DP) White	\$7.98 H

Boater Sports Thru-Hull Connectors



- Corrosion proof.
- For use above the waterline.

Order No.	Mfg. No. / Description	Price
1-57221	(57221) 5/8" Hose White	\$3.25 H
1-57222	(57222) 3/4" Hose White	\$4.30 H
1-57224	(57224) 1-1/8" Hose White	\$4.99 H

- Fun & Flotation
- Anchor & Dock
- Safety
- Electronics
- Trolling Motors
- Lighting
- Electrical
- Topside Acc.
- Cockpit & Deck
- Instruments
- Steering, Controls
- Perform.
- Fuel System
- Engine & Parts
- Engine Care
- Propellers
- Seating & Pedestals
- Tops & Covers
- Pumps**
- Cleaning & Care
- Paint & Paint Acc.
- Hardware, Fasteners
- Trailering
- Misc.
- Comm.

Forespar Thru-Hull Connectors - Plastic

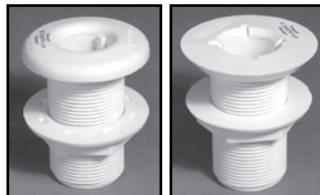

251 Series

250 Series

- For connection to seacox, ball valves or hose.
- Molded in high strength glass reinforced "Marelon" for superior corrosion protection.
- For use above or below the waterline.
- Must be installed with proper bedding compound.

251 SERIES - FULL THREADED/MUSHROOM HEAD

Order No.	Mfg. No. / Description	Length	Price
353588	(906012) 3/4" Thread	Length 2-1/4"	\$17.98 F
353589	(906014) 1" Thread	Length 2-3/8"	\$19.98 F
353590	(906016) 1-1/4" Thread	Length 3"	\$22.98 F
353603	(906018) 1-1/2" Thread	Length 3"	\$29.98 F

253 SERIES - HOSE TAILPIPE/MUSHROOM HEAD

Order No.	Mfg. No. / Description	Price
353639	(906022) Hose ID 1/2" - 5/8"	\$15.98 F
353641	(906024) Hose ID 3/4"	\$17.98 F
353653	(906026) Hose ID 1"	\$20.98 F
353665	(906028) Hose ID 1-1/4"	\$22.98 F
353677	(906030) Hose ID 1-1/2"	\$29.98 F

Attwood Thru-Hull Connector with Strainer



- Acetal construction.
- Thru-hull connector with strainer prevents clogging of the aerator pump.
- Strainer attaches to threads that extend beyond external retaining nut.
- Caution: Do not use strainer as a thru-hull connector nut replacement.
- Thru-hull connectors are designed for installation above the water line only.
- Fits 3/4" ID hose, maximum hull thickness: 1-7/16".

Order No.	Mfg. No. / Description	Price
2350061	(3886-3) White	\$13.98 H

Boater Sports Bilge Pump Plumbing Kit



- Complete the installation of your bilge pump with ease using this plumbing kit.
- Kit includes: Plastic bilge hose, thru-hull fitting and (2) stainless steel clamps.

Order No.	Mfg. No. / Description	Price
1-57304	(57304) 3/4" x 5'	\$12.85 H

T-H Marine Plastic Thru-Hull Connectors - Extended Length

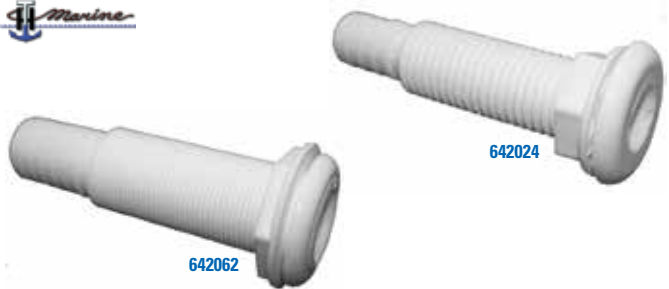

642062

642024

- Made of the highest quality virgin material to insure consistent size and extra durability.

HOSE ID 3/4". LENGTH 4-1/2"

- Maximum hull thickness: 3". Flange diameter: 1-3/4".

Order No.	Mfg. No. / Description	Price
642024	(TH-752XL-DP) White	\$5.98 R

HOSE ID 1-1/8". LENGTH 5-3/8"

- Maximum hull thickness: 3-3/8". Flange diameter: 1-7/8".

Order No.	Mfg. No. / Description	Price
642062	(TH-1202XL-DP) White	\$7.98 H

HOSE ID 1-1/2". LENGTH 5-3/8"

- Maximum hull thickness: 3-1/4". Flange diameter: 2-7/8".

Order No.	Mfg. No. / Description	Price
641427	(TH-1502XLDP) White	\$11.98 H

T-H Marine Standard Tee Fittings



- 3-way barbed tee.

Order No.	Mfg. No. / Description	Price
641375	(TEE-3/4-DP) Hose 3/4" ID	\$3.33 H
6400288	(TEE-118-DP) Hose 1-1/8" ID	\$3.85 H

Buck-Algonquin "Tuff-Lite" Nylon Tees



Order No.	Mfg. No. / Description	Price
354617	(60TSSS222) Tube ID 1/4"	\$2.97 F
354629	(60TSSS333) Tube ID 3/8"	\$2.97 F
354631	(60TSSS444) Tube ID 1/2"	\$2.98 F

- Fun & Flotation
- Anchor & Dock
- Safety
- Electronics
- Trolling Motors
- Lighting
- Electrical
- Topside Acc.
- Cockpit & Deck
- Instruments
- Steering, Controls
- Perform.
- Fuel System
- Engine & Parts
- Engine Care
- Propellers
- Seating & Pedestals
- Tops & Covers
- Pumps
- Cleaning & Care
- Paint & Paint Acc.
- Hardware, Fasteners
- Trailer
- Misc.
- Comm.

Perko Fig. 709 Pump Strainer



- Cast bronze.
- Hose 5/8".
- Length overall 3-5/8".
- Width overall 1-3/4".

Order No.	Mfg. No. / Description	Price
541727	(0709 DPO PLB)	\$59.98 R

Perko Fig. 722 Pump Strainer

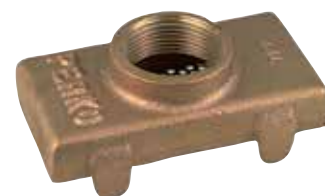

- Cast bronze.
- Pipe 1-1/4".
- Length overall 4-1/2".
- Width overall 2-3/4".

Order No.	Mfg. No. / Description	Price
541791	(0722 000 PLB)	\$123.98 Q

Buck-Algonquin Navy Pump Strainers



- Dimensions: 3-1/2" x 5".

Order No.	Mfg. No. / Description	Price
256873	(20NPSB150) Aluminum For 1-1/2" Nipple	\$117.98 H
256885	(20NPSB200) Aluminum For 2" Nipple	\$121.98 H
256900	(00NPS200) Cast Bronze For 2" Nipple	\$118.98 H

Buck-Algonquin Rectangular Scoop Strainers



- Cast bronze.
- Slide-out removable screens.

Order No.	Mfg. No. / Description	Price
256708	(00RSS655P) Dimensions: 10-5/16" L x 4-5/8" W	\$162.98 H
256710	(00RSS1100P) Dimensions: 12-3/4" L x 5-7/8" W	\$227.98 H
256709	(00RSS655PS) Screen Only for 256708	\$45.98 H
256711	(00RSS110PS) Screen Only for 256710	\$46.98 H

Buck-Algonquin Rectangular Scoop Strainer



- Cast bronze.
- Complete with stainless steel perforated screen.
- Dimensions: 10" L x 4-1/2" W. Inside dimensions: 5-9/16" L x 3" W.
- Maximum thru-hull: 2".

Order No.	Mfg. No. / Description	Price
256683	(00RSS650P)	\$123.98 H

Sen-Dure Water Strainer



- Bronze.
- For seacock inlets up to 2-1/2".
- Overall size: 15" x 5-7/8".

Order No.	Mfg. No. / Description	Price
605014	(0910)	\$332.98 E

Groco ASC Series - Slotted Hull Strainers



- Bronze.
- Access to the thru-hull fitting and seacock beneath GROCO hull strainers is made easy with the patented access door design.
- Now there is no need to remove the entire strainer to clear nuisance marine growth.

Order No.	Mfg. No. / Description	Price
S/O	(ASC-1250) Max. T-Hull 1-1/4" 7" L x 3.38" W x 1.5" D	POR
374166	(ASC-2000) Max. T-Hull 2" 10.25" L x 4.38" W x 1.63" D	\$174.98 Q
S/O	(ASC-3000) Max. T-Hull 3" 15.38" L x 6" W x 2" D	POR
S/O	(ASC-6000) Max. T-Hull 4" 20.25" L x 11" W x 4" D	POR

Groco Bronze Intake Strainers



- Bronze.
- NPT thru-hull fitting with integral scoop strainer.

Order No.	Mfg. No. / Description	Price
256734	(STH500W) Pipe 1/2"	\$29.98 Q
256746	(STH750W) Pipe 3/4"	\$37.98 Q
256758	(STH1000W) Pipe 1"	\$44.98 Q
256772	(STH1250W) Pipe 1-1/4"	\$65.98 Q
256784	(00IS150) Pipe 1-1/2"	\$148.98 H
256785	(00IS200) Pipe 2"	\$180.98 H

Groco APHS Series - Perforated Hull Strainers



- Bronze.
- Access to the thru-hull fitting and seacock beneath GROCO hull strainers is made easy with the patented access door design.
- Now there is no need to remove the entire strainer to clear nuisance marine growth.

Order No.	Mfg. No. / Description	Price
S/O	(APHS-1250-1) Max. T-Hull 1-1/4" 7" L x 3.38" W x 1.5" D	POR
S/O	(APHS-2000-1) Max. T-Hull 2" 10.25" L x 4.38" W x 1.63" D	POR
S/O	(APHS-3000-1) Max. T-Hull 3" 15.38" L x 6" W x 2" D	POR
S/O	(APHS-6000-1) Max. T-Hull 4" 20.25" L x 11" W x 4" D	POR

Bronze Scoop Strainers



- Bronze.
- Converts standard thru-hull to high speed intake strainer.

Order No.	Mfg. No. / Description	Price
256633	(00SS500) Fits Thru-Hull 3/4" 5" L x 3-1/4" W	\$39.98 H
256645	(SC1000L) Fits Thru-Hull 1" 5-1/4" L x 3-5/8" W	\$21.98 Q
256657	(0066 DP3 PLB) Fits Thru-Hull 1-1/4" & 1-1/2" 6-1/4" L x 4-1/4" W	\$50.98 F
256669	(SC2500L) Fits Thru-Hull 2-1/2" 8-1/2" L x 6" W	\$70.98 Q

- Fun & Flotation
- Anchor & Dock
- Safety
- Electronics
- Trolling Motors
- Lighting
- Electrical
- Topside Acc.
- Cockpit & Deck
- Instruments
- Steering, Controls
- Perform.
- Fuel System
- Engine & Parts
- Engine Care
- Propellers
- Seating & Pedestals
- Tops & Covers
- Pumps
- Cleaning & Care
- Paint & Paint Acc.
- Hardware, Fasteners
- Trailering
- Misc.
- Comm.

Groco RSC Series - Round Slotted Hull Strainers

GROCO.



- Bronze.
- Access to the thru-hull fitting and seacock beneath GROCO hull strainers is made easy with the patented access door design.
- Now there is no need to remove the entire strainer to clear nuisance marine growth.

Order No.	Mfg. No. / Description	Price
S/O	(RSC-1000) Max. T-Hull 1" Diameter 3.63" Height 0.56" POR	
S/O	(RSC-2000) Max. T-Hull 2" Diameter 5.20" Height 0.83" POR	
S/O	(RSC-4000) Max. T-Hull 4" Diameter 9.00" Height 1.30" POR	

Buck-Algonquin Bronze Intake Water Strainer - Low Profile

BUCK ALGONQUIN



- Bronze.
- Clear plexiglass top.
- Hose 1-1/2". Tapped for 1" pipe.
- Outside diameter 6-1/8".
- Overall height 5-7/16", overall length 8-1/8".

Order No.	Mfg. No. / Description	Price
257205	(00IWS150)	\$633.98 H
257229	(COIWS1215LG) Replacement Gasket	\$12.98 H
257245	(70IWS1215R) Screen Only	\$17.98 H

Groco WSB Series - Pump Inlet Strainers

GROCO.



- Protect fresh water pumps from debris.
- White nylon strainer head and clear plastic sight glass.
- Glass unscrews for filter basket cleaning.
- Mount bracket included.
- For fresh water systems.

Order No.	Mfg. No. / Description	Price
S/O	(WSB-500) 1/2" NPT	Price on Request
S/O	(WSB-750) 3/4" NPT	Price on Request
S/O	(WSB-1000) 1" NPT	Price on Request
S/O	(WSB-1250) 1-1/4" NPT	Price on Request

Raritan Raw Water Strainer

RARITAN
The Most Dependable Name on the Water



- Wise addition to all seawater intake lines.
- Trash and waterflow can be monitored through this clear plastic body.
- Nylon strainer basket can be removed without tools.
- Inlet and outlet 1-1/2" NPT female pipe thread.
- Plastic fittings must be used.

Order No.	Mfg. No. / Description	Price
564268	(RWS) Height 9-3/4"	\$159.98 F

Forespar Water Strainer

FORESPAR MARELON



- Molded in high strength glass reinforced "Marelon" for superior corrosion protection.
- It features an integral mounting bracket and clear polycarbonate lid for ready inspection.
- Intake and exit ports are 1-1/2" threads standard.
- The flow rate is 40 GPM.

Order No.	Mfg. No. / Description	Price
353401	(906066) Diameter 6.3", Height 6.1"	\$167.98 F

Perko Fig. 86 Round Strainers

PERKO
MADE IN THE USA



- Cast bronze.
- For mounting over thru-hull or other draining needs.
- Drilled holes.

Order No.	Mfg. No. / Description	Price
542678	(0086 DP2 PLB) OD 3" Thru-Hull 3/4"	\$22.98 R
542680	(0086 DP3 PLB) OD 3-1/2" Thru-Hull 1"	\$23.98 R
542692	(0086 DP4 PLB) OD 4" Thru-Hull 1-1/4" and 1-1/2"	\$30.98 R
542705	(0086 DP5 PLB) OD 5" Thru-Hull 2"	\$58.98 R
542717	(0086 006 PLB) OD 6" Thru-Hull 2-1/2"	\$75.98 Q

Buck-Algonquin Black Polyethylene Strainers

BUCK ALGONQUIN



Order No.	Mfg. No. / Description	Price
256722	(60TSS25) Size 2"	\$15.98 H
256735	(60TSS35) Size 3"	\$31.98 H

Shurflo Raw Water Strainers

SHURFLO
Durable Water



- Built to keep bait tank, livewell and washdown pumps protected from harmful debris.
- Features a clear twist off bowl and removable stainless steel screen, which allows for easy inspection and cleaning.
- An integral o-ring creates a tight seal, eliminating possible leaks.
- Screen: Mesh T304 SS.

Order No.	Mfg. No. / Description	Price
375190	(253-220-01) Inlet/Outlet Ports: 3/4" NPT-F	\$41.98 F
375205	(253-400-01) Inlet/Outlet Ports: 1-1/4" NPT-F	\$63.98 F

Jabsco "Pumpgard" In-Line Strainers

JABSCO



- Prevents dirt and particles from entering pump intake, cuts repairs.
- Works in any position.
- Transparent inspection housing.
- Just remove one screw for easy cleaning.

Order No.	Mfg. No. / Description	Price
414754	(36400-0000) 1/2" ID hose, 50 Mesh Screen	\$28.98 Q
414350	(36200-0000) 3/4" ID hose, 16 Mesh Screen	\$26.98 Q

Johnson Pump PUMProtector Universal Strainers

Johnson Pump



- Transparent covers for simple inspection.
- Easy to install and remove for thorough cleaning thanks to KlickTite port connectors.
- Diameter 3.15". Height 2.35".
- 2x 1/2" barb/3/8" NPT. 2x 3/4" barb/1/2" NPT.

Order No.	Mfg. No. / Description	Price
471374	(092465202CN) Stainless Steel 40 mesh	\$17.98 R
462334	(09-2465204CN) Stainless Steel 20 mesh	\$16.98 G

- Fun & Flotation
- Anchor & Dock
- Safety
- Electronics
- Trolling Motors
- Lighting
- Electrical
- Topside Acc.
- Cockpit & Deck
- Instruments
- Steering, Controls
- Perform.
- Fuel System
- Engine & Parts
- Engine Care
- Propellers
- Seating & Pedestals
- Tops & Covers
- Pumps
- Cleaning & Care
- Paint & Paint Acc.
- Hardware, Fasteners
- Trailer
- Misc.
- Comm.

Perko Fig. 493 Intake Water Strainers



Order No.	Mfg. No. / Description	Price
538946	(0493 004 PLB) Pipe 1/2" Height 5-3/4" Cylinder 3-1/2" x 4" Width 4-1/2"	\$267.98 Q
538958	(0493 005 PLB) Pipe 3/4" Height 8-3/8" Cylinder 3-1/2" x 6" Width 4-1/2"	\$288.98 Q
538960	(0493 006 PLB) Pipe 1" Height 9-1/2" Cylinder 4-1/2" x 5-1/2" Width 5-1/2"	\$404.98 Q
538972	(0493 007 PLB) Pipe 1-1/4" Height 10" Cylinder 4-1/2" x 6" Width 5-1/2"	\$408.98 Q
538984	(0493 008 PLB) Pipe 1-1/2" Height 11-1/2" Cylinder 6" x 8" Width 7-1/4"	\$566.98 E
538996	(0493 009 PLB) Pipe 2" Height 16" Cylinder 6" x 12" Width 7-1/2"	\$700.98 E
539001	(0493 010 PLB) Pipe 2-1/2" Height 16" Cylinder 6" x 12" Width 7-1/2"	\$703.98 E

- Cast bronze.
- Stainless steel bracket.
- Clear polymer cylinder.
- Features include mounting lugs cast into both sides to assure universal mounting, four outside tie rods and a 316 stainless steel strainer basket to minimize electrolysis.
- Screen hole size diameter .079", 47% open area.
- Hinged lugs for the cast bronze cover permit easy removal and cleaning of the strainer basket.
- A drain plug in the bottom casting is provided for easily removing sediment and draining for winterizing.
- Tested and accepted for labeling and UL listed.

SPARE PARTS

Order No.	Mfg. No. / Description	Price
539075	(0493 010 99C) Transparent Cylinder Only - 99C	\$178.98 Q
539095	(0493-005 99D) Basket Strainer - 99D	\$72.98 Q
539102	(0493-006 99D) Basket Strainer - 99D	\$90.98 Q
539114	(0493-007 99D) Basket Strainer - 99D	\$101.98 Q
539126	(0493-008 99D) Basket Strainer - 99D	\$135.98 Q
539138	(0493-009 99D) Basket Strainer - 99D	\$175.98 Q
539140	(0493-010 99D) Basket Strainer - 99D	\$195.98 Q

539291	(0493 DP5 99M) (1) Cover and (2) Cylinder Gaskets - 99M	\$27.98 R
539316	(0493 DP7 99M) (1) Cover and (2) Cylinder Gaskets - 99M	\$27.98 R
539328	(0493 DP9 99M) (1) Cover and (2) Cylinder Gaskets - 99M	\$39.98 R
539377	(0493 DP5 99L) Hinged Bolt for Cover - 99L	\$33.98 R
539378	(0493 DP7 99L) Hinged Bolt for Cover - 99L	\$36.98 R
539379	(0493 DP9 99L) Hinged Bolt for Cover - 99L	\$50.98 R
539295	(0493 DP5 99R) Rubber Gasket Kit #4/#5	\$28.98 R
539300	(0493 DP7 99R) Rubber Gasket Kit #6/#7	\$38.98 E

Order No.	Mfg. No. / Description	Price
538946	(0493 004 PLB) N/A	
538958	(0493 005 PLB) N/A	
538960	(0493 006 PLB) N/A	
538972	(0493 007 PLB) N/A	
538984	(0493 008 PLB) N/A	
538996	(0493 009 PLB) 539075 (0493 010 99C) \$178.98 Q	
539001	(0493 010 PLB) 539075 (0493 010 99C) \$178.98 Q	

Groco ARG Series Water Strainers



Order No.	Mfg. No. / Description	Price
373009	(ARG-500-S) Pipe 1/2" Cylinder Diameter 3.5" Cylinder Height 4"	\$191.98 H
373011	(ARG-750-S) Pipe 3/4" Cylinder Diameter 3.5" Cylinder Height 6"	\$190.98 H
373023	(ARG-1000-S) Pipe 1" Cylinder Diameter 4.5" Cylinder Height 5.75"	\$263.98 H
373035	(ARG-1250-S) Pipe 1-1/4" Cylinder Diameter 4.5" Cylinder Height 7.75"	\$274.98 H
373037	(ARG-1500-S) Pipe 1-1/2" Cylinder Diameter 6" Cylinder Height "	\$363.98 H
373039	(ARG-2000-S) Pipe 2" Cylinder Diameter 6" Cylinder Height 9.56"	\$440.98 H
373041	(ARG-2500-S) Pipe 2-1/2" Cylinder Diameter 6" Cylinder Height 11.56"	\$510.98 H
373043	(ARG-3000-S) Pipe 3" Cylinder Diameter 6" Cylinder Height 13.94"	\$567.98 H

- Bronze castings with clear sight glass.
- #304 stainless steel filter basket.
- No tie rods or gaskets.
- No leaks under pressure or vacuum.
- Buna-N O-ring seals.
- Routine maintenance and service without too...
- Spanner wrench holes in screw-on cap allow use of Groco SW-2531 spanner wrench if desired.
- Available in 1/2" to 3" female pipe sizes.
- Repair kit includes: Sight glass O-ring, cap O-ring, O-ring and washer.

REPLACEMENT FILTER BASKETS

Order No.	Mfg. No. / Description	Price
373112	(BS-1) For ARG-500-S	\$40.98 Q
373124	(BS-2) For ARG-750-S	\$42.98 Q
373136	(BS-3) For ARG-1000-S	\$46.98 Q
373148	(BS-5) For ARG-1250-S	\$49.98 Q

STRAINER REPAIR KIT

- Repair kit for 1" and 1-1/4" pipe.
- Includes: Sight glass O-ring, cap O-ring, O-ring and washer.

Order No.	Mfg. No. / Description	Price
373097	(ARG-2)	\$17.98 Q

- Fun & Flotation
- Anchor & Dock
- Safety
- Electronics
- Trolling Motors
- Lighting
- Electrical
- Topside Acc.
- Cockpit & Deck
- Instruments
- Steering, Controls
- Perform.
- Fuel System
- Engine & Parts
- Engine Care
- Propellers
- Seating & Pedestals
- Top & Covers
- Pumps**
- Cleaning & Care
- Paint & Paint Acc.
- Hardware, Fasteners
- Trailering
- Misc.
- Comm.

- Fun & Flotation
- Anchor & Dock
- Safety
- Electronics
- Trolling Motors
- Lighting
- Electrical
- Topside Acc.
- Cockpit & Deck
- Instruments
- Steering, Controls
- Perform.
- Fuel System
- Engine & Parts
- Engine Care
- Propellers
- Seating & Pedestals
- Tops & Covers
- Pumps
- Cleaning & Care
- Paint & Paint Acc.
- Hardware, Fasteners
- Trailing
- Misc.
- Comm.

Perko Fig. 500 Heavy Duty Intake Water Strainer



- Cast bronze with stainless steel basket.
- Pipe 3". Cylinder 8" x 14". Height 18-1/2". Width 9".
- High capacity with diesels and large gasoline engines.
- Features include mounting lugs cast into both sides to assure universal mounting, four outside tie rods and a 316 stainless steel strainer basket to minimize electrolysis.
- Screen hole size diameter .079", 47% open area.
- Hinged lugs for the cast bronze cover permit easy removal and cleaning of the strainer basket.
- A drain plug in the bottom casting is provided for easily removing sediment and draining for winterizing.
- Tested and accepted for labeling and UL listed.

Order No.	Mfg. No. / Description	Price
539506	(0500 011 PLB)	\$1,291.98 E
539520	(0500 011 99D) Basket Strainer	\$370.98 Q
539532	(0500 DP9 99M) Cork Gasket Kit: (1) Cover Gasket and (2) Cylinder Gaskets	\$57.98 R
539535	(0500 DP9 99R) Rubber Gasket Kit	\$57.98 R
539544	(0500 DP9 99L) Hinged Bolt for Cover with Pin, Nut & Washer	\$53.98 R

Groco SD Series Water Strainers



- Stainless steel filter basket with clear sight glass.
- Monel inside tie rod.
- Naval bronze outside tie rods.
- Bronze wingnut spins off for easy access to filter basket.

Order No.	Mfg. No. / Description	Price
S/O	(SD-1500-S) Pipe 1-1/2" Cylinder Diameter 9.00" Cylinder Height 14.50"	Price on Request
373908	(SD-2000-S) Pipe 2" Cylinder Diameter 9.00" Cylinder Height 16.00"	\$1,202.98 E
373910	(SD-2500-S) Pipe 2-1/2" Cylinder Diameter 9.00" Cylinder Height 19.13"	\$1,356.98 E
373922	(SD-3000-S) Pipe 3" Cylinder Diameter 9.00" Cylinder Height 22.25"	\$1,444.98 E

SPARE PARTS

Order No.	Mfg. No.	Filter Basket, S/S	Cylinder	Strainer Repair Kit
373908	(SD-2000-S)	373960 - \$1,202.98 E	N/A	373946 - \$34.98 F
373910	(SD-2500-S)	373972 - \$1,356.98 E	N/A	373946 - \$34.98 F
373922	(SD-3000-S)	373984 - \$1,444.98 E	374025 - \$302.98 F	373946 - \$34.98 F

Order No.	Mfg. No. / Description	Price
374075	(S-85) Wingnut for SD-2000, SD-2500 & SD-3000	\$35.98 F
374087	(SD-14) Strainer Cap for SD-2000, SD-2500 & SD-3000	\$176.98 F
374099	(SD-16) End Cap for SD-2000, SD-2500 & SD-3000	\$276.98 F
374126	(SD-20-B) Outside Tie Rod for SD-3000	\$14.98 F
373960	(SSD-17) Stainless Steel Filter Basket for SD-2000	\$197.98 F
373972	(SSD-17-A) Stainless Steel Filter Basket for SD-2500	\$203.98 F
373984	(SSD-17-B) Stainless Steel Filter Basket for SD-3000	\$206.98 F
373954	(SD-2500-H) Strainer Head for SD-2500	\$812.98 LQ
373955	(SD-3000-H) Strainer Head for SD-3000	\$827.98 F
374025	(SD-21-B) Cylinder for SD-3000	\$302.98 F

STRAINER REPAIR KIT

- Repair kit for for 2", 2-1/2" and 3" pipe.
- Includes: Sight glass O-ring, cap O-ring, O-ring and washer.

Order No.	Mfg. No. / Description	Price
373946	(SD)	\$34.98 F

Groco SA Series High-Capacity Water Strainers



- #304 stainless steel filter basket with clear sight glass.
- Monel inside tie rod.
- Easy service with spin-off-wingnut.

Order No.	Mfg. No. / Description	Price
373364	(SA-1000-S) Pipe 1" Cylinder Diameter 5.00" Cylinder Height 10.50"	\$427.98 H
373376	(SA-1250-S) Pipe 1-1/4" Cylinder Diameter 5.00" Cylinder Height 12.75"	\$460.98 H
373388	(SA-1500-S) Pipe 1-1/2" Cylinder Diameter 6.25" Cylinder Height 13.75"	\$669.98 H
373390	(SA-2000-S) Pipe 2" Cylinder Diameter 6.25" Cylinder Height 16.50"	\$858.98 H
373403	(SA-2500-S) Pipe 2-1/2" Cylinder Diameter 6.25" Cylinder Height 18.75"	\$956.98 H

SPARE PARTS

Order No.	Mfg. No. / Description	Price
373718	(SVS-5) Wingnut for SA-1000 and SA-1250	\$14.98 F
373720	(S-75) Wingnut for SA-1500, SA-2000 and SA-2500	\$20.98 F
373768	(S-82-A) End Cap for SA-1500, SA-2000 and SA-2500	\$150.98 Q
373578	(S-87-A) Tie Rod for SA-2000	\$7.98 F
373528	(SS-76) Stainless Steel Filter Basket for SA-1000-S	\$33.98 LQ
373530	(SS-76-A) Stainless Steel Filter Basket for SA-1250-S	\$32.98 LQ
373542	(BS-6) Stainless Steel Filter Basket for SA-1500-S	\$50.98 F
373554	(BS-8) Stainless Steel Filter Basket for SA-2000-S	\$54.98 F
373566	(BS-11) Stainless Steel Filter Basket for SA-2500-S	\$56.98 F
373631	(S-88-A) Cylinder for SA-2000-S	\$143.98 F
373643	(S-88-B) Cylinder for SA-2500-S	\$174.98 F

STRAINER REPAIR KIT

- Includes: Sight glass O-ring, cap O-ring, O-ring and washer.

Order No.	Mfg. No. / Description	Price
373453	(SA-2) For 1" to 1-1/4" Pipe	\$26.98 G
373465	(SA-3) For 1-1/2" to 2-1/2" Pipe	\$25.98 G

Groco SE Series - Large Engine Water Strainers

GROCO



373939



373934

- For high powered engines with 4", 5" or 6" intake.
- Cap and basket have replaceable zinc anode protection.
- Low restriction for maximum cooling water flow.
- No inside tie rods.
- Cover unscrews for easy filter basket cleaning.
- O-rings seal all mating surfaces.
- Improved cylindrical filter basket.
- Bronze castings. Lucite sight glass. Stainless steel filter basket.

MODEL SE SERIES

- Cylinder diameter 13". Cylinder height 18.4".

Order No.	Mfg. No. / Description	Price
373934	(SE-4000) 4" NPT	\$7,160.98

MODEL SEF SERIES

- Cylinder diameter 16.5". Cylinder height 18.4". Mounting bolts: 3/4".

Order No.	Mfg. No. / Description	Price
373939	(SEF4000) 4" Flange	\$8,333.98 Q
S/O	(SEF-5000) 5" Flange	Price on Request
S/O	(SEF-6000) 6" Flange	Price on Request

ACCESSORIES

Order No.	Mfg. No. / Description	Price
373950	Repair Kit	\$45.98 F
373951	(SE-4001A) Cap	\$667.98 F
373959	(SE-4003-1) Monel Basket	\$1,352.98

Beckson Thirsty-Mate® Hand Bilge Pumps

Beckson

- It is self-priming and very easy to clean.
- All plastic.
- Self lubricating.
- This hand pump will not rust or corrode or mar your boat.
- If your THIRSTY-MATE hand pump becomes clogged, simply remove the foot valve assembly and clean out the inside.
- Includes: Flexible hose.
- Manufactured in the USA.



Order No.	Mfg. No. / Description	Price
247456	(118PF) 18" with 20" Hose 10 Strokes per Gallon	\$33.98 R
247470	(124PF) 24" with 24" Hose 6 Strokes per Gallon	\$38.98 F
247482	(124PF6) 24" with 72" Hose 6 Strokes per Gallon	\$52.98 G
247494	(136PF) 36" with 36" Hose 4 Strokes per Gallon	\$48.98 G
247507	(136PF6) 36" with 72" Hose 4 Strokes per Gallon	\$57.98 G

Perko Fig. 693 Heavy Duty Intake Water Strainer for 4" Pipe

PERKO



- Cast bronze.
- Pipe 4". Cylinder 8-3/4" x 12". Height 17-1/2". Width 16-1/2".
- Basket: 6-3/4" x 8-5/8".
- Ratio: 10:1.
- High capacity with diesels and large gasoline engines.
- Features include mounting lugs cast into both sides to assure universal mounting, four outside 316 stainless steel tie rods and nuts.
- Screen hole size diameter .079", 47% open area.
- Aircraft style mounting nuts hold fast without lock washers.
- A drain plug in the bottom casting is provided for easily removing sediment and draining for winterizing.
- Tested and accepted for labeling and UL listed.

Order No.	Mfg. No. / Description	Price
539556	(0693 012 PLB)	\$4,945.98 E

Boater Sports Hand Bilge Pump

BOATER SPORTS



- 24" hand bilge pump with 36" hose.
- Perfect for use on small boats, dinghies and lockers or any other place water collects.

Order No.	Mfg. No. / Description	Price
1-57004	(57004)	\$24.95 H

Beckson Thirsty-Mate® High Capacity Hand Super Pump

Beckson

- High capacity pump.
- Self lubricating.
- This hand pump will not rust or corrode or mar your boat.
- Length 24".
- Diameter 3".
- Capacity 22 GPM.
- 3 strokes per gallon.
- Provided with 2" wire reinforced vinyl hose.
- Inlet hose: Length 4'. Outlet hose: Length 6'.



Order No.	Mfg. No. / Description	Price
247533	(519-C)	\$293.98 G

- Fun & Flotation
- Anchor & Dock
- Safety
- Electronics
- Trolling Motors
- Lighting
- Electrical
- Topside Acc.
- Cockpit & Deck
- Instruments
- Steering, Controls
- Perform.
- Fuel System
- Engine & Parts
- Engine Care
- Propellers
- Seating & Pedestals
- Tops & Covers
- Pumps**
- Cleaning & Care
- Paint & Paint Acc.
- Hardware, Fasteners
- Trailering
- Misc.
- Comm.

Rule Non-Automatic Bilge Pumps



- Fully submersible.
- Ignition protected.
- Compact, efficient long life motor.
- Easy clean snap lock strainer.
- Silent and vibrationless operation.
- No burn-out when run dry.
- Rust and corrosion protection. Anti-airlock protection.
- 12 volt.



Order No.	Mfg. No. / Description	Price
582000	(24) 360 GPH Discharge 3/4" 3-1/2" H x 2-3/8" W	\$23.98 F
582026	(25D) 500 GPH Discharge 3/4" 3-1/2" H x 2-3/8" W	\$29.98 F
582042	(20R) 800 GPH Discharge 3/4" 3-3/4" H x 2-3/8" W	\$51.98 R
582064	(27D) 1,100 GPH Discharge 1-1/8" 4-1/4" H x 2-3/8" W	\$55.98 G

Rule Side Mount Bracket for Bilge Pumps



- Permits small Rule bilge pumps to be side mounted to a vertical stringer, a bulkhead or a transom.
- Use this bracket when bottom mounting is inconvenient or impossible.
- Simply remove the strainer from the pump, put the bracket in place, and reassemble.
- For use with Rule 360, 500, 800 and 1,100 GPH bilge pumps.



Order No.	Mfg. No. / Description	Price
582886	(66)	\$7.98 H

Johnson Bilge Mate Pump



- A low budget alternative designed for long life and high performance capacity.
- Bracket molded to pump.
- Connection 3/4".
- Amperage 2.5A, Fuse size 5A.
- 12 volt.
- Made in the USA.



Order No.	Mfg. No. / Description	Price
470514	(21405) 400 GPH	\$22.98 R

Marpac Cartridge Bilge Pump



- Extended life water cooled motor.
- Thermoplastic housing resists heat and stress.
- High grade 316 stainless steel shaft.
- Lightweight glass resin composite impeller resists breakage.
- Meets and exceeds ABYC, U.S. Coast Guard, NMMA and IMCI (ISO 8849) specifications.
- Straight and omni-directional 90° hose barbs and backflow check valve included.
- Heavy duty 16 gauge corrosion resistant tinned wire.
- Quick change motor cartridge replacement (Order No. 7-2218).
- 3/4" OD discharge port.
- 12 volt.



Order No.	Description	Price
7-0442	750 GPH	\$33.98 G
7-2218	Replacement Motor Cartridge	\$33.98 G

Rule Non-Automatic Bilge Pumps



- Fully submersible.
- Ignition protected.
- Compact, efficient long life motor.
- Easy clean snap lock strainer.
- Silent and vibrationless operation.
- No burn-out when run dry.
- Width 2-7/8", height 4".
- Rust and corrosion protection. Anti-airlock protection.
- 12 volt.



Order No.	Mfg. No. / Description	Price
582040	(20F) 800 GPH Discharge 3/4"	\$52.98 R
582052	(20A) 1,000 GPH Discharge 1-1/8"	\$52.98 R

Boater Sports Non-Automatic Bilge Pumps



- Bilge pumps have universal mounting base allowing pumps to snap into competitors bases without modification to mounting holes or position.
- All pumps are ignition protected and meet USCG requirements.



Order No.	Mfg. No. / Description	Price
1-57412	(57412) 600 GPH 3/4" Outlet	\$21.35 R
1-57420	(57420) 800 GPH 3/4" Outlet	\$23.99 H
1-57426	(57426) 1,100 GPH 1-1/8" Outlet	\$25.60 H

Boater Sports Cartridge Bilge Pump



- Cartridge design means simplified maintenance and unmatched safety when out on the water.
- Cartridge easily exchanges between bilge pumps or livewell pumps in case of pump failure.
- High impact, fully sealed construction.



Order No.	Mfg. No. / Description	Price
1-57446	(57446) 800 GPH	\$26.95 H
1-57433	(57433) Replacement Cartridge	\$24.95 H

Attwood Tsunami Series Cartridge Bilge Pumps



- Rugged, glass-filled and mineral-filled polymer body withstands hull pounding, bilge environments and deteriorating effects of plasticizers in hoses.
- Depress base tab to unlock filter from housing - ideal for maneuvering in tight spaces and for cleaning filter.
- Motor cartridges are replaceable.
- Improved motor and seal for longer life.
- 12 volt.



Order No.	Mfg. No. / Description	Price
236059	(4606-7) T-500 500 GPH Outlet 3/4"	\$24.98 R
236078	(4608-7) T-800 800 GPH Outlet 3/4"	\$38.98 H
236112	(4612-7) T-1200 1,200 GPH Outlet 1-1/8"	\$49.98 H
236060	(4620-6) Replacement Motor Cartridge for 236059	\$20.98 R
236079	(4622-6) Replacement Motor Cartridge for 236078	\$30.98 H
236081	(4624-6) Replacement Motor Cartridge for 236112	\$41.98 H

Fun & Flotation

Anchor & Dock

Safety

Electronics

Trolling Motors

Lighting

Electrical

Topside Acc.

Cockpit & Deck

Instruments

Steering, Controls

Perform.

Fuel System

Engine & Parts

Engine Care

Propellers

Seating & Pedestals

Pumps

Cleaning & Care

Paint & Paint Acc.

Hardware, Fasteners

Trailer

Misc.

Comm.

Johnson Pump Cartridge Bilge Pump



- Removable and upgradable motor cartridge bilge pump for easy maintenance and repair.
- The pumps are delivered including both a straight and a 90° smooth elbow DuraPort as well as a removable check valve.
- Connection 3/4"
- 12 volt.
- Made in the USA.



Order No.	Mfg. No. / Description	Price
470687	(32502) 500 GPH	\$30.98 H
470532	(32703) 750 GPH	\$44.98 Q
470548	(32102) 1,000 GPH	\$53.98 Q
470726	(28512) Spare Cartridge for 1,000 GPH	\$46.98 Q

Johnson Proline Bilge Pumps - DuraPorts



- Pro-Line Bilge Pumps DuraPorts includes straight and 90°.
- Connection 3/4"
- Bracket molded to pump.
- Includes removable check valve.
- 12 volt.
- Made in the USA.



Order No.	Mfg. No. / Description	Price
470524	(22502) 500 GPH	\$32.98 Q
470536	(22702) 750 GPH	\$48.98 Q
470462	(22102) 1,000 GPH	\$64.98 R

Johnson Pump Low Boy Bilge Pump



- Low profile pump design for ease of mounting and removal in tight bilge areas.
- Perfect for vessels with bilge pumps mounted beneath inboard or I/O engines.
- Removable cartridge style.
- Includes: DuraPorts both a straight and a 90° externally threaded fitting.
- Use 36152 magnetic switch only.
- 12 volt.
- Made in the USA.



Order No.	Mfg. No. / Description	Price
470688	(33703) 750 GPH Connection 3/4"	\$48.98 Q
470689	(33103) 1,250 GPH Connection 1-1/8"	\$62.98 Q

Johnson Pump Heavy Duty High Capacity Bilge Pumps

Order No.	Mfg. No. / Description	Price
470447	(16004-00) 1,600 GPH 12 volt 1-1/8" and 1-1/4"	\$104.98 R
470134	(16084) 1,600 GPH 24 volt 1-1/8" and 1-1/4"	\$135.98 R
470461	(22004) 2,200 GPH 12 volt 1-1/8" and 1-1/4"	\$136.98 R
470450	(22084) 2,200 GPH 24 volt 1-1/8" and 1-1/4"	\$158.98 R
470138	(22084) 2,200 GPH 24 volt 1-1/8" and 1-1/4"	\$156.98 LQ
470497	(40004) 4,000 GPH 12 volt 1-1/2" and 2"	\$252.98 R
470499	(40084) 4,000 GPH 24 volt 1-1/2" and 2"	\$272.98 R

Johnson Pump 1250 GPH Cartridge Bilge Pump



- Incorporate some of the most advanced features in the industry, features developed from service in a wide variety of uses including racing, cruising, sport fishing and demanding commercial duties.
- Removable and upgradable motor cartridge bilge pump for easy maintenance and repair.
- Connection 1-1/8"
- 12 volt.
- Made in the USA.



Order No.	Mfg. No. / Description	Price
470232	(42123) 1,250 GPH	\$60.98 R

Boater Sports High Output Bilge Pumps



- Turbo designed impeller.
- Ignition protected, submersible.
- Includes stainless steel mounting hardware.
- Tinned marine grade wire.
- Quick release mount allows easy access to clean debris from strainer.
- 1-1/8" outlet.
- 12 volt.



Order No.	Mfg. No. / Description	Price
1-57430	(57430) 1,500 GPH	\$58.95 H
1-57435	(57435) 2,000 GPH	\$62.95 H

Rule LoPro Series Bilge Pumps



- Only 2-1/4" tall - about half the height of a normal bilge pump.
- The entire body swivels up to 180°, making the pump extremely easy to install.
- Includes: 3/4" straight, 3/4" right angle, 1" and 1-1/8".
- Automatic version can be set to pump at 1.3", 2" or check for water every 2 minutes.
- Backflow preventer valve can be used with straight fittings.
- Dimensions: 2.3" H x 9.3" L. Width: as little as 2.3".
- 12 volt.



Order No.	Mfg. No. / Description	Price
582333	(LP900S) 900 GPH Automatic	\$71.98 E
582335	(LP900D) 900 GPH	\$50.98 E

- Fun & Flotation
- Anchor & Dock
- Safety
- Electronics
- Trolling Motors
- Lighting
- Electrical
- Topside Acc.
- Cockpit & Deck
- Instruments
- Steering, Controls
- Perform.
- Fuel System
- Engine & Parts
- Engine Care
- Propellers
- Seating & Pedestals
- Tops & Covers
- Pumps
- Cleaning & Care
- Paint & Paint Acc.
- Hardware, Fasteners
- Trailering
- Misc.
- Comm.

Rule Non-Automatic Bilge Pumps



- Fully submersible.
- Compact, efficient long life motor.
- Ignition protected.
- Silent and vibrationless operation.
- No burn-out when run dry.
- Rust and corrosion protection.
- Anti-airlock protection.
- Easy clean snap lock strainer.
- Discharge 1-1/8".
- Height 6", width 4-1/4".



Order No.	Mfg. No. / Description	Price
582456	(02) 1,500 GPH 12 volt	\$95.98 E
582494	(10) 2,000 GPH 12 volt	\$130.98 E
582496	(10-6UL) 2,000 GPH 12 volt (UL Listed)	\$167.98 F
582519	(12) 2,000 GPH 24 volt	\$168.98 F
582521	(11) 2,000 GPH 32 volt	\$173.98 F

GOLD-SERIES - 5 YEAR WARRANTY

- Easy clean triple stage snap lock strainer. Heavy 5/16" stainless steel shaft.

Order No.	Mfg. No. / Description	Price
582482	(09) 2,000 GPH 12 volt	\$178.98 F

Rule Hose Adapters



- Heavy duty molded, non-corrosive, high impact plastic.
- For Rule 1,000, 1,100, 1,500, 2,000 and 5-Year Pumps.



Order No.	Mfg. No. / Description	Price
582812	(68) Adapts 1-1/8" Outlet to Standard Garden Hose Fitting	\$9.98 H
582824	(69) For Adapting 1-1/8" Outlet to 3/4" or 5/8" ID Hose	\$7.98 H

Rule Non-Automatic Bilge Pumps



- Fully submersible. Ignition protected.
- Easy clean snap lock strainer.
- Silent and vibrationless operation.
- No burn-out when run dry.
- Rust & corrosion protection. Anti-airlock protection.
- Discharge 1-1/2".
- Width 4-7/8", height 7-1/4".



Order No.	Mfg. No. / Description	Price
582545	(14A) 3,700 GPH 12 volt	\$249.98 F
582557	(16A) 3,700 GPH 24 volt	\$272.98 F
582571	(15A) 3,700 GPH 32 volt	\$268.98 F

Rule Non-Automatic Bilge Pump



- Fully submersible. Ignition protected.
- Easy clean snap lock strainer.
- Silent and vibrationless operation.
- No burn-out when run dry.
- Rust & corrosion protection. Anti-airlock protection.
- Discharge 2".
- Width 4-7/8", height 7-3/4".



Order No.	Mfg. No. / Description	Price
582584	(56D) 4,000 GPH 12 volt	\$274.98 F
582785	(72) Thru Hull Fitting 2" Straight	\$39.98 LQ

Attwood Heavy Duty Bilge Pumps



- Integrate the highest quality bearings, brushes, alloys and magnets designed to withstand extreme usage cycles.
- Pump all employs an exclusive shaft and motor compartment, reducing wear and significantly extending pump life.
- Advanced resin compositions incorporated in exterior to resist chemicals such as engine oil, aggressive detergents and hose plasticizers.
- Attwood's Heavy Duty bilge has unsurpassed durability and efficiency in a compact design to ensure electrical energy is converted to the pump rather than excess heat.
- Dimensions: 5.97" H x 3.83" W.
- Hose size: 1-1/8" ID.

Order No.	Mfg. No. / Description	Price
236090	(4730-4) 1,700 GPH 12 volt	\$106.98 G
236095	(4760-4) 2,000 GPH 12 volt	\$140.98 H
236100	(4770-4) 2,000 GPH 24 volt	\$147.98 R

Rule Automatic Bilge Pumps



- Computerized operation - no float switch required.
- Anti-Airlock protection.
- Compact, efficient, long life motor.
- No burn-out when run dry.
- Easy clean snap-lock strainer bases.
- Completely submersible.
- Rust and corrosion protection.
- Silent and vibrationless operation.
- Ignition protected.
- 12 volt.



500 GPH BILGE PUMP

- Discharge 3/4".
- 2-3/8" W x 4" H.

Order No.	Mfg. No. / Description	Price
582305	(25S) 500 GPH	\$77.98 E

1,100 GPH BILGE PUMP

- Discharge 1-1/8".
- 2-3/8" W x 4-1/2" H.

Order No.	Mfg. No. / Description	Price
582329	(27S) 1,100 GPH	\$124.98 E

1,500 AND 2,000 GPH BILGE PUMPS

- 3 wire version allows manual override or indicator light capability.
- Discharge 1-1/8".

Order No.	Mfg. No. / Description	Price
582216	(51S) 1,500 GPH 4-7/8" W x 8-1/4" H	\$197.98 E
582222	(53S) 2,000 GPH 4-3/4" W x 7-3/4" H	\$269.98 E

Fun & Flotation

Anchor & Dock

Safety

Electronics

Trolling Motors

Lighting

Electrical

Topside Acc.

Cockpit & Deck

Instruments

Steering, Controls

Perform.

Fuel System

Engine & Parts

Engine Care

Propellers

Seating & Pedestals

Tops & Covers

Pumps

Cleaning & Care

Paint & Paint Acc.

Hardware, Fasteners

Trailer

Misc.

Comm.

Boater Sports Automatic Bilge Pump with Float Switch



- Bilge pump has universal mounting base allowing pump to snap into competitors bases without modification to mounting holes or position.
- Ignition protected and meet USCG requirements.
- 3/4" outlet.

Order No.	Mfg. No. / Description	Price
1-57422	(57422) 800 GPH	\$38.75 H

Johnson Pump Auto Bilge Pump

Johnson Pump



- Combines the line of cartridge bilge pumps with automatic operation.
- Removable and upgradeable motor cartridge bilge pump for easy maintenance and repair.
- The pumps are delivered including both a straight and a 90° smooth elbow DuraPort as well as a removable check valve.
- Equipped with a non-clogging electronic float switch.
- Connection 3/4"
- 12 volt.
- Made in the USA.

Order No.	Mfg. No. / Description	Price
470526	(05503-00) 550 GPH	\$68.98 Q
470538	(05703-00) 750 GPH	\$82.98 Q

Johnson Pump Heavy Duty Bilge Pump Automatic

Johnson Pump



- Heavy duty bilge pump equipped with either a Electro-magnetic or Ultima Switch.
- This pump has a liquid cooled, 12-pole motor with double ball bearings for extended service life.
- Removable check valve included.
- Connection 1-1/8" and 1-1/4".
- Made in the USA.

Order No.	Mfg. No. / Description	Price
470146	(01604-00) 1,600 GPH 12 volt Electro-Magnetic	\$167.98 R
470150	(01604-002) 1,600 GPH 24 volt Electro-Magnetic	\$172.98 R
470240	(01674-001) 1,600 GPH 12 volt Ultima Switch	\$184.98 R
470241	(01674-002) 1,600 GPH 24 volt Ultima Switch	\$179.98 LQ
470154	(02204-00) 2,200 GPH 12 volt Electro-Magnetic	\$207.98 R
470158	(02204-002) 2,200 GPH 24 volt Electro-Magnetic	\$212.98 R
470242	(02274-001) 2,200 GPH 12 volt Ultima Switch	\$223.98 R

Rule Large Capacity Automatic Bilge Pump



- Heavy duty construction for both commercial and pleasure boat use.
- Known for trouble free operation and reliability.
- Discharge 1-1/2".
- Width 4-7/8", height 8-1/4".
- 12 volt.

Order No.	Mfg. No. / Description	Price
5815039	(55S) 3,700 GPH	\$427.98 H

Johnson Pump Bilge Pump Ultima Combo

Johnson Pump



- Pump with automatic operation equipped with the Ultima switch.
- **470528, 470529** and **470530** includes a straight and a 90° smooth elbow DuraPorts external fittings and a removable check valve.
- 12 volt.
- Made in the USA.

Order No.	Mfg. No. / Description	Price
470528	(07503-00) 500 GPH Connection 3/4"	\$84.98 Q
470529	(07703-00) 750 GPH Connection 3/4"	\$99.98 Q
470530	(07903-00) 1,000 GPH Connection 3/4"	\$110.98 Q
470531	(08203-00) 1,250 GPH Connection 1-1/8"	\$132.98 Q

Marpac Premier Automatic Bilge Pumps



- A rugged ABS fuel resistant housing with patented "Field Effect" sensing technology that uses micro electrical fields to turn the pump on/off when water is detected.
- Advanced digital design that is Mercury free with no float switch to be jammed on or off.
- The simple 3 wire design is easy to install and can be run in auto or manual override mode.
- Straight and omni-directional 90° hose barbs, as well as a backflow check valve are included.
- Made in USA, this pump is NMMA, ABYC, USCG and CE Certified.
- Includes a 3 year warranty.

Order No.	Description	Price
7-2206	600 GPH	\$63.98 G
7-2208	800 GPH	\$84.98 G
7-2212	1,250 GPH	\$133.98 G

Attwood Sahara Series Automatic Bilge Pumps

- Includes pump, wire, seals, strainer and mercury-free switch.
- 36" lengths of 16-gauge caulked and tinned copper wire.
- Permanent magnet motor lubricated bearings for longer life.
- 316 stainless steel motor shaft for saltwater corrosion resistance.
- Molded seal prevents leak paths.
- Quick, one-handed removal for easy cleaning.
- Dimensions: 5-1/2" L x 4" H x 3-1/4" W.
- 12 volt.



Order No.	Mfg. No. / Description	Price
236186	(4505-7) 500 GPH Hose Size 3/4" ID	\$65.98 H
236198	(4507-7) 750 GPH Hose Size 3/4" ID	\$99.98 H
236201	(4511-7) 1,100 GPH Hose Size 1-1/8" ID	\$117.98 H

- Fun & Flotation
- Anchor & Dock
- Safety
- Electronics
- Trolling Motors
- Lighting
- Electrical
- Topside Acc.
- Cockpit & Deck
- Instruments
- Steering, Controls
- Perform.
- Fuel System
- Engine & Parts
- Engine Care
- Propellers
- Seating & Pedestals
- Tops & Covers

Pumps

- Cleaning & Care
- Paint & Paint Acc.
- Hardware, Fasteners
- Trailering
- Misc.
- Comm.

- Fun & Flotation
- Anchor & Dock
- Safety
- Electronics
- Trolling Motors
- Lighting
- Electrical
- Topside Acc.
- Cockpit & Deck
- Instruments
- Steering, Controls
- Perform.
- Fuel System
- Engine & Parts
- Engine Care
- Propellers
- Seating & Pedestals
- Tops & Covers
- Pumps
- Cleaning & Care
- Paint & Paint Acc.
- Hardware, Fasteners
- Trailer
- Misc.
- Comm.

Rule-Mate® Fully Automatic Bilge Pumps



- Anti-Airlock protection.
- No burn-out when run dry.
- Exclusive moisture tight seals.
- Completely submersible.
- Easy clean snap-lock strainer bases.
- Stainless steel shafts.
- Silent and vibrationless operation.
- Ignition protection.
- Rust and corrosion protection.
- All-in-one pump and switch - No float switch required.
- 12 volt.

Order No.	Mfg. No. / Description	Price
582348	(RM500A) 500 GPH Discharge 3/4"	\$61.98 E
582360	(RM750A) 750 GPH Discharge 3/4"	\$86.98 E
582370	(RM1100A) 1,100 GPH Discharge 1-1/8"	\$112.98 E
582379	(RM1500A) 1,500 GPH Discharge 1-1/8"	\$214.98 F
582381	(RM2000A) 2,000 GPH Discharge 1-1/8"	\$275.98 F

Rule 110 Volt Automatic Utility Pumps



- Designed to remove water from basements, garages, stairwells, utility rooms, backyards, sumps, pools, pool covers, boats and other utility applications.
- Computerized automation eliminates need for float switches.
- Automatically checks for water every few minutes.
- Turns on when only 1" of water is detected.
- Totally submersible in fresh or salt water.
- Includes: Garden hose adapter and 90° elbow adapter for 1" NPT pipe.
- Discharge 1-1/8".
- 1,800 GPH.
- 110V AC.
- UL Listed.

Order No.	Mfg. No. / Description	Price
582575	(A53S) Includes 8' Cord	\$239.98 F
582580	(A53S-24) Includes 24' Cord	\$246.98 F

Rule Combo Bilge Pump and Float Switch



- Includes: 582026 (25D) 500 GPH Bilge Pump and 582696 (40A) Rule-A-Matic Plus Float Switch.
- 3 year warranty on pump and 2 year warranty on float switch.

Order No.	Mfg. No. / Description	Price
582038	(25-40A) 500 GPH	\$84.98 G

Johnson Ultima Bilge Pumps



- Integrated pump and digital float switch-on demand, quiet operation.
- 470120, 470122 and 470124 includes a straight and a 90° smooth elbow DuraPorts external fittings and a removable check valve.
- 12 volt.
- Made in the USA.

Order No.	Mfg. No. / Description	Price
470120	(32-47258-003) 600 GPH Connection 3/4"	\$67.98 Q
470122	(32-47259-003) 800 GPH Connection 3/4"	\$84.98 Q
470124	(32-47260-003) 1,000 GPH Connection 3/4"	\$95.98 Q
470126	(32-47261-002) 1,250 GPH Connection 1-1/8" & 1-1/4"	\$116.98 Q

Boater Sports Bilge Pump with Float Switch



- 600 GPH bilge pump packaged with 1-57438 (57438) float switch.
- Ignition protected and meet USCG requirements.
- 3/4" outlet.

Order No.	Mfg. No. / Description	Price
1-57418	(57418) 600 GPH	\$26.95 H

Rule Combo Bilge Pump and Float Switch



- Includes: 582000 (24) 360 GPH Bilge Pump and 582646 (35A) Rule-A-Matic Float Switch.
- 3 year warranty on pump and 2 year warranty on float switch.

Order No.	Mfg. No. / Description	Price
582076	(24-35A) 360 GPH	\$55.98 G

Rule Combo Bilge Pump and Float Switch



- Includes: 582042 (20R) 800 GPH Bilge Pump and 582646 (35A) Rule-A-Matic Float Switch.

Order No.	Mfg. No. / Description	Price
582030	(20R-35A) 800 GPH	\$61.98 G

Boater Sports Automatic Float Switch



- Automatic ball-type switch - no mercury - with tinned marine-grade wire.
- For use with most 12 volt bilge pumps.
- 15 amp.
- Simple installation, mounting hardware included.

Order No.	Mfg. No. / Description	Price
1-57438	(57438)	\$7.95 H

Rule Rule-A-Matic® Float Switches



- Mercury-free snap switch tested to over one million cycles.
- Designed for pumps drawing up to 14 amps.
- Includes a removable base for easy cleaning and servicing, and marine grade "blocked" wire.
- Dimensions: 4-1/2" x 1-1/2" x 2".
- 2 year warranty.

Order No.	Mfg. No. / Description	Price
582646	(35A) Without Fuse Holder	\$33.98 E
582658	(35FA) With Fuse Holder	\$43.98 F

Rule Switch Adapter

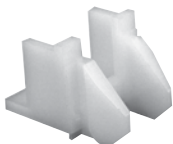

- Adapter to attach Rule SuperSwitch or Rule-A-Matic to Rule 1,500, 2,000 or 5-Year Bilge Pumps.

Order No.	Mfg. No. / Description	Price
582800	(65)	\$3.15 I

Johnson Pump Automatic Float Switch



- For full automatic bilge pumping operation, connect the automatic switch to a bilge pump.
- Has a time-proven micro switch without mercury.
- When water exceeds the acceptable level, the pump is turned on by a rolling steel ball changes the pressure, which changes the pressure on the micro switch.
- Can be used with 6, 12, 24 or 32 volt systems.

Order No.	Mfg. No. / Description	Price
470055	(26014)	\$17.98 Q

Sure Bail Automatic Float Switch



- Mercury switch potted in a urethane foam float will never waterlog.
- High impact polypropylene case protects float and prevents failures due to debris lodging on top or under the float.
- For manual operation simply rotate the external shaft.
- Width 2-7/8", length 5-1/2".
- 5 year warranty.

Order No.	Mfg. No. / Description	Price
470017	(900-2000)	\$32.98 H

Rule SuperSwitch™ Float Switches



- A 5 year warranty, the non-mercury SuperSwitch is designed for the toughest applications.
- Design includes marine grade 14 gauge "blocked wire", larger float for increased buoyancy, and removable base for easy servicing.
- Design capable of handling pumps drawing up to 20 amps.
- Dimensions: 2-1/4" x 5" x 2".

Order No.	Mfg. No. / Description	Price
582662	(37A) Without Fuse Holder	\$60.98 F
582660	(37FA) With Fuse Holder	\$61.98 F

Rule Rule-A-Matic® Plus™ Float Switches



- Sleek and rugged, the Rule-A-Matic Plus float switch has a strong, fully integrated and impact resistant cover, which protects against debris and jamming.
- 14 gauge highly abrasive resistant marine grade wire, and a built-in test feature.
- Designed for pumps drawing up to 20 amps.
- Dimensions: 3" x 5-3/8" x 2-1/2".
- 2 year warranty.

Order No.	Mfg. No. / Description	Price
582698	(40A) Without Fuse Holder	\$47.98 E
582696	(40FA) With Fuse Holder	\$50.98 F

Attwood Automatic Float Switches



- Converts any bilge pump that draws 12 amps (at 12 VDC) or 6 amps (at 24 VDC) or less to fully automatic operation.
- Compact, low-profile design that mounts on any surface from horizontal up to a 24° angle.
- Incorporates a reliable and affordable mechanical switch that actuates pump motor at 2" water level.
- Contains no mercury, a "Persistent Toxic Substance," listed as a health hazard in more than 26 states.

Order No.	Mfg. No. / Description	Price
236162	(4202-7) 1-3/8" H x 3-7/8" W x 4-1/4" L	\$30.98 H
236174	(4201-7) With Cover 2-7/8" H x 3-7/8" W x 5-1/4" L	\$35.98 H

Sure Bail Electronic Float Switch



- Environmentally safe, contains no mercury.
- High-impact polypropylene case.
- On at 2" of water, off at 1/2".
- ROHS Compliant (Regulations on Hazardous Substances).
- Solid state electronic relay switch sealed in urethane within the float.
- Manual operation-simply rotate the external shaft.

Order No.	Mfg. No. / Description	Price
470029	(902-2000)	\$70.98 H

- Fun & Flotation
- Anchor & Dock
- Safety
- Electronics
- Trolling Motors
- Lighting
- Electrical
- Topside Acc.
- Cockpit & Deck
- Instruments
- Steering, Controls
- Perform.
- Fuel System
- Engine & Parts
- Engine Care
- Propellers
- Seating & Pedestals
- Tops & Covers
- Pumps**
 - Cleaning & Care
 - Paint & Paint Acc.
 - Hardware, Fasteners
 - Trailering
 - Misc.
 - Comm.

Marpac Premier Electronic Bilge Switch



- Solid state automatic bilge water detection.
- No moving parts, completely enclosed design.
- Sensors only activate when exposed to water.
- Works with both fresh and salt water.
- Multiple mounting options.
- Ignition protected - ISO 8846:1990.

Order No.	Description	Price
7-2228	Electronic Bilge Switch	\$50.98 F

Johnson Pump Electronic Float Switch



- Compact mechanical switch offers a combination of reliable solid state electronics and a sealed float switch.
- False start prevention, no mercury, high impact plastic and encapsulated electronics adds up to dependability.
- Activates pump at 2" water level, deactivates pump at 3/4" water level.
- Made in the USA.

Order No.	Mfg. No. / Description	Price
471363	(36152) 12 volt	\$22.98 Q
471364	(36252) 24 volt	\$22.98 LQ

Johnson Pump Bilge Alert™



- High water alarm featuring digital technology using the patented Mirus field effect.
- Totally sealed fluid detector are never in contact with water, will not corrode and are not affected by oil or debris.
- Bilge alert detects water and sends a signal (3 second delay for sloshing) to the alarm and switch conveniently mounted on a panel.
- Three way rocker switch allows alarm to be tested, turned off and armed.
- 12 volt.
- Made in the USA.

Order No.	Mfg. No. / Description	Price
471351	(72303) Includes Sensor	\$101.98 G
471353	(72303-001) Includes Ultima Switch	\$101.98 G

Boater Sports 3-Way Bilge Pump Switch



- Marine grade tinned wire with aluminum face plate and booted toggle switch.
- LED Power indicators.
- 10 amp breaker.
- 3 positions: On/Off/Auto.

Order No.	Mfg. No. / Description	Price
1-57444	(57444) Dimensions: 3-1/4" x 2"	\$19.95 H

Johnson Pump Ultima Switch™



- Patented Mirus field effect detector cells producing micro-electrical field that detect disruptions caused by water and fluids.
- Detector cells are totally sealed and are never in contact with the water, will not corrode and are not affected by oil or foreign debris.
- No moving parts, totally sealed, no mercury.
- Ultima Switch, 12 and 24 volt in same switch, up to 20 amps.
- A 3 second delay prevents false starts.
- Made in the USA.

Order No.	Mfg. No. / Description	Price
471365	(36303)	\$51.98 Q

Marpac Premier High Water Bilge Alarm



- SensaLevel detects so perfectly because it eliminates failure prone parts.
- NO seals to leak, NO moving contacts to corrode, NO moving levers to become jammed and NO effect from temperature, humidity or vibration.
- The SensaLevel Detector Cell surrounds itself with a micro-electrical field.
- When rising water disrupts that field, it triggers the alarm.
- Activation is accurate - no missed signals or false alarms.

Order No.	Description	Price
7-2230	High Water Bilge Alarm	\$92.98 G

Rule High-Water Bilge Alarm



- Consists of a float switch and an in-dash gauge that features both a visual and an audible 85 db alarm.
- Allows an unmanned compartment to be constantly monitored.
- For additional compartments add additional Rule Float Switches.
- Complies with CFR 182.530 which requires a visual and audible alarm in each unmanned space on commercial vessels at least 26' in length.

Order No.	Mfg. No. / Description	Price
581505	(33ALA)	\$88.98 G

Johnson Pump Panel Bilge Pump Switch



- Matt black finish has integrated fuse holder and operating light.
- Button for the manual or automatic bilge pumping.
- The automatic feature operates in combination with the automatic bilge switches or the electronic float switch.
- Dimensions: 2.99" x 2.17" x 1.57" depth.

Order No.	Mfg. No. / Description	Price
471361	(82004) 2-Way	\$34.98 G
471362	(82044) 3-Way	\$36.98 G

- Fun & Flotation
- Anchor & Dock
- Safety
- Electronics
- Trolling Motors
- Lighting
- Electrical
- Topside Acc.
- Cockpit & Deck
- Instruments
- Steering, Controls
- Perform.
- Fuel System
- Engine & Parts
- Engine Care
- Propellers
- Seating & Pedestals
- Tops & Covers
- Pumps
- Cleaning & Care
- Paint & Paint Acc.
- Hardware, Fasteners
- Trailer
- Misc.
- Comm.

Rule 2-Way Panel Switch



- Black stainless steel panel.
- Simple “on” or “off” toggle provides fingertip control.
- Dimensions: 2-1/4” x 2”.
- 12/24/32 volt.
- For any manually operated system.

Order No.	Mfg. No. / Description	Price
582759	(49)	\$25.98 E

Rule 3-Way Panel Switch - Standard



- Black stainless steel panel.
- Controls any pump equipped with an automatic float switch.
- Toggle has 3 position: Automatic, Off or Manual.
- Dimensions: 2-1/4” x 2”.
- 12/24/32 volt.

Order No.	Mfg. No. / Description	Price
582735	(45)	\$26.98 E

Rule 3-Way Panel Lighted Switches - Deluxe



- Black stainless steel with a red indicator light and fuse holder.
- Controls any pump equipped with an automatic float switch.
- Toggle has 3 positions: Automatic, Off and Manual.
- The “manual” position has a “fail-safe” spring return to “off”.
- Dimensions: 3-1/4” x 2”.

Order No.	Mfg. No. / Description	Price
582709	(41) 12 volt	\$35.98 E
582711	(42) 24/32 volt	\$36.98 E

Rule 3-Way Panel Lighted Rocker Switch



- For use with any automatically controlled pump.
- This unit features a black plastic panel, a built-in fuse holder and an internally lighted rocker switch with 3 positions (automatic, off or manual) with the Rule “fail-safe” spring return to “off” from the “manual” position.
- Dimensions: 2-7/8” x 2-3/8”.

Order No.	Mfg. No. / Description	Price
582713	(43)	\$35.98 E

Jabsco Medium and Heavy Duty Bilge Pumps



- Fully serviceable, bilge pump.
- Allows mounting above wet bilges.
- Diaphragm design allows extended dry running.
- Complete with Pumpgard strainer.
- Self-priming so they can be remotely mounted in a high and dry location.
- Corrosive resistant base assembly.
- Belt drive and rubber mounting pads reduce noise and vibration.
- Connections for 3/4” ID hose.
- 12 volt.

Order No.	Mfg. No. / Description	Price
414235	(36680-2000) 5.5 GPM	\$469.98 E
414261	(36600-0000) 8 GPM	\$520.98 E
414350	(36200-0000) Spare Pumpgard Strainer	\$26.98 Q

Jabsco Light Duty Bilge Pump



- Self-priming allows pump to be mounted above bilge and sump areas with only the intake hose in the bilge.
- Diaphragm design allows extended dry running.
- Connections for 3/4” ID hose.
- Complete with Pumpgard strainer.
- 12 volt.

Order No.	Mfg. No. / Description	Price
414211	(36960-2000) 4 GPM	\$387.98 F
414350	(36200-0000) Spare Pumpgard Strainer	\$26.98 Q

Jabsco Bilge Pump Service Kit



- Kit includes: Replacement belt, diaphragm, valves, and pulsation dampeners to restore the performance of old or worn out pumps.
- For use with Bilge Pump (36600 Series).

Order No.	Mfg. No. / Description	Price
416026	(30124-0000)	\$132.98 F

Jabsco 12 volt Bilge Motor



- Spare or replacement motor for ITT Jabsco 12V DC Bilge Pumps.
- For models: 36900, 36800, 36950, 34600 and 36600.
- 12 volt.

Order No.	Mfg. No. / Description	Price
416138	(30200-0000)	\$173.98 F

- Fun & Flotation
- Anchor & Dock
- Safety
- Electronics
- Trolling Motors
- Lighting
- Electrical
- Topside Acc.
- Cockpit & Deck
- Instruments
- Steering, Controls
- Perform.
- Fuel System
- Engine & Parts
- Engine Care
- Propellers
- Seating & Pedestals
- Tops & Covers
- Pumps**
- Cleaning & Care
- Paint & Paint Acc.
- Hardware, Fasteners
- Trailering
- Misc.
- Comm.

Jabsco Flexible Impeller Pedestal Pumps

- Jabsco pedestal pumps are constructed from marine quality bronze and stainless steel for ruggedness and reliability.
- Ideal for engine cooling, washdown, circulation and many general purpose on-board or dockside applications.
- The shaft is installed with permanently lubricated ball bearings for long life and heavy duty service.

- Self-priming with the ability to operate in either direction variable speeds.
- Removable end cover for easy impeller service.
- Handles hard and soft solids without clogging.
- Can pump in either direction.
- Will not airlock.

Jabsco Flexible Impeller Pedestal Pump



- 5.8 GPM.
- Port Type: 3/8" NPT Internal.
- 1/2" diameter shaft.
- Lip seal.

Order No.	Mfg. No. / Description	Price
417898	(2620-1101) Pump	\$307.98 G
418500	(18673-0001-P) Neoprene Impeller	\$46.98 G

Jabsco Flexible Impeller Pedestal Pump



- 11.0 GPM.
- Port Type: 1/2" NPT.
- 5/8" diameter shaft.
- Lip seal.

Order No.	Mfg. No. / Description	Price
417902	(16731-001) Pump	\$367.98 F
418309	(1210-0001-P) Neoprene Impeller	\$37.98 G

Jabsco Flexible Impeller Pedestal Pump



- 23.3 GPM.
- Port Type: 1" NPT Internal.
- 5/8" diameter shaft.
- Mechanical face seal.

Order No.	Mfg. No. / Description	Price
417940	(777-9001) Pump	\$397.98 F
418361	(920-0001-P) Neoprene Impeller	\$41.98 G

Jabsco Flexible Impeller Pedestal Pump



- 62 GPM.
- Port Type: 1-1/4" NPT Internal.
- 1" diameter shaft.
- Carbon-Ceramic face seal.
- Full thickness cam, neoprene impeller and standard shaft.

Order No.	Mfg. No. / Description	Price
417964	(7420-0004) Pump	\$751.98 G
418435	(836-0001-P) Neoprene Impeller	\$60.98 G

Jabsco Flexible Impeller Pedestal Pumps



- 62 GPM.
- Port Type: 1-1/4" NPT Internal.
- 1" diameter shaft.
- Carbon-Ceramic face seal.
- 417954 - Short shaft for CAT Engines.

Order No.	Mfg. No. / Description	Price
417953	(6400-0004) Pump	\$660.98 G
417954	(6400-1051) Pump	\$581.98 E
418435	(836-0001-P) Neoprene Impeller	\$60.98 G

Jabsco Flexible Impeller Pedestal Pump



- 83 GPM.
- Port Type: 2" NPT Internal.
- 1" diameter shaft.
- Carbon-Ceramic face seal.

Order No.	Mfg. No. / Description	Price
417976	(18370-0000) Pump	\$1,289.98 G
418457	(17936-0001-P) Neoprene Impeller	\$111.98 G

Jabsco Cummins K19 125 GPM 2 HOL



Order No.	Mfg. No. / Description	Price
418106	(18770-0003)	\$4,040.98 G

Jabsco Cummins Vortex Pump



Order No.	Mfg. No. / Description	Price
418120	(15780-0000)	\$8,875.98 G

Jabsco Engine Cooling Pump - Flange Mount



- Constructed from marine quality bronze and stainless steel for ruggedness and reliability.
- For Flagship, Palmer Lehman and Chris Craft Engines.
- Flow rate: Nominal 40 Litres/min (10.6 US gallons/min) at 1,500 rpm.
- Self-priming from dry up to 2.4 m (7.8 ft.).
- Port Type: 3/4" NPT.
- Seal: Lip type. Bearings: Twin single row, ball type.

Order No.	Mfg. No. / Description	Price
418093	(5850-0001) Pump	\$629.98 F
418309	(1210-0001-P) Neoprene Impeller	\$37.98 G

Jabsco Sherwood Type Engine Cooling Pump - Bracket Mount



- Constructed from marine quality bronze and stainless steel for ruggedness and reliability.
- Replaces Sherwood Model G-5 pump.
- Flow rate: Nominal 56 Litres/min (15 US gallons/min) at 1,500 rpm.
- Self-priming from dry up to 2.4 m (7.8 ft.).
- Alternator mount.
- Pulley drive - 6-1/2" Full Grip "A" Belt.
- Seal: Carbon-Ceramic face type. Bearings: Twin single row, ball type.
- Port Type: 1-1/4" ID hose.

Order No.	Mfg. No. / Description	Price
418078	(18940-0010) Pump	\$769.98 F
418599	(11979-0001-P) Neoprene Impeller	\$53.98 Q

- Fun & Flotation
- Anchor & Dock
- Safety
- Electronics
- Trolling Motors
- Lighting
- Electrical
- Topside Acc.
- Cockpit & Deck
- Instruments
- Steering, Controls
- Perform.
- Fuel System
- Engine & Parts
- Engine Care
- Propellers
- Seating & Pedestals
- Tops & Covers
- Pumps
- Cleaning & Care
- Paint & Paint Acc.
- Hardware, Fasteners
- Trailer
- Misc.
- Comm.

Johnson Engine Cooling Pump

Johnson Pump

- For Onan, Westerbeke.
- Port Size: 3/8" NPT.
- Mounting type: Pedestal.
- Mechanical seal.
- Impeller: 09-808B-1. Service Kit: 09-46840.



Order No.	Mfg. No. / Description	Price
461944	(10-24569-09) F35B-8	\$232.98 E
462262	(9-808B-1) Impeller	\$24.98 G
462868	(09-45589) Service Kit (Lip Seal)	\$52.98 G

Johnson Engine Cooling Pump

Johnson Pump

- Bronze body, flexible impeller, stainless steel shaft, universal application.
- Port Size: 1" NPT.
- Mounting type: Pedestal.
- Mechanical seal.
- Impeller: 09-1028BT-1. Service Kit: 09-47427.



Order No.	Mfg. No. / Description	Price
461513	(10-24572/51) F7B-8	\$358.98 LQ
462034	(09-1028BT-1) Impeller	\$45.98 G

Johnson Crankshaft Style Engine Cooling Pump

Johnson Pump

- Featured on Indmar, Marine Power, Volvo, PCM engines.
- 15% more flow.
- Bronze body, stainless steel shaft, flexible impeller, flange mounted, vertical ports, OEM pumps.
- Impeller: 09-812B-1.



Order No.	Mfg. No. / Description	Price
461401	(10-24805-01) F6B-9	\$229.98 G
462250	(09-812B-1) Impeller	\$50.98 G
462907	(09-45825) Service Kit	\$81.98 G

Johnson Crankshaft Style Engine Cooling Pump

Johnson Pump

- Featured on older style small block GM marine engines.
- Bronze body, stainless steel shaft, flexible impeller, flange mounted, vertical ports, OEM pumps.
- Impeller: 09-1027B-10.



Order No.	Mfg. No. / Description	Price
461385	(10-24228-1) F5B-9	\$287.98 G
462248	(09-1027B-10) Impeller	\$38.98 G

Johnson Engine Cooling Pump

Johnson Pump

- F9B-9 Gear Driven without flange.
- Fits Detroit Diesel Engine Models 671T, 871 and 1271.
- 2 port connection.
- Impeller: 09-814B.



Order No.	Mfg. No. / Description	Price
461828	(10-13095-02) F9B-9	\$1,250.98 LQ
462301	(09-814B) Impeller	\$115.98 G

Johnson Electro-Magnetic Clutch Pump

Johnson Pump

- Ports: 1-1/4" NPT.
- Mechanical seal.
- 12 volt 2xA Pulley with Clutch Bronze body.
- Impeller: 09-819B. Service Kit: 09-45575.
- Cross to Jabsco 11870-0005.



Order No.	Mfg. No. / Description	Price
461777	(10-1302295-1) F8B-50017	\$885.98 G
462310	(09-819B-00) Impeller	\$76.98 G

Johnson Pump Flexible Impeller Pump

Johnson Pump

- Offers a high level of flexibility making them ideally suited as bilge, deckwash, oil or diesel transfer pumps and various other duties.
- Connection: Hose 1" and 1/2" NPT.
- Ignition protected. 12 volt.
- Impeller: 09-824P-9 (Nitrile).



Order No.	Mfg. No. / Description	Price
461866	(10-24689-03) F4B-19, 12 GPM	\$337.98 Q
462286	(09-824P-9) Impeller	\$38.98 G

Johnson Pump Impeller Replacement Kit

Johnson Pump

- EX Reverse Design. Run dry capable.
- Replaces: Johnson 09-824p-1; Jabsco 6303-0007-P (Green).
- Fits Johnson 12V 10-24690-03 Ballast Pump, 24V 10-24690-04 Ballast Pump; Jabsco 12V 18220-1127.



Order No.	Mfg. No. / Description	Price
470178	(09-824P-1EZ)	\$38.98 G

Johnson Accessories for Engine Cooling Pump

Johnson Pump

- For Original OEM impeller F95. Neoprene.

Order No.	Mfg. No. / Description	Price
462313	(09-820B) Impeller	\$319.98 G
463098	(0.2172.142) O-ring	\$5.98 G

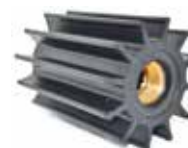

Johnson Electro-Magnetic Clutch Assembly

- Fits F7B-5, F8B-5 and F9B-5 clutch pumps.
- Double A pulley.
- 12 volt.

Order No.	Mfg. No. / Description	Price
462995	(0.3454.001)	\$221.98 F



Johnson Pump Impellers

Order No.	Mfg. No. / Description	Price
462274	(09-1026B-1) Fits Pump F4	\$29.98 G
462299	(09-806B-1) Fits Pump F35, MC97	\$36.98 G
462300	(09-810B-1) Fits Pump F4, MC97	\$29.98 G
462302	(09-810B-9) Fits Pump F4B, Nitrile	\$34.98 G
462312	(09-819B-9) Fits Pump F8B, Nitrile	\$101.98 G
462320	(09-824P-1) Fits Ultra Ballast Pump	\$41.98 LQ
462322	(09-1026B-9) Fits Pump F4B, Nitrile	\$58.98 G
462324	(09-1029B) Fits Pump F8B, Neoprene	\$87.98 G
462326	(09-1052S-9) Fits Pump TA3P10, Nitrile	\$26.98 G
462328	(09-1077B-9) Fits Pump F2, Nitrile	\$40.98 G

- Fun & Flotation
- Anchor & Dock
- Safety
- Electronics
- Trolling Motors
- Lighting
- Electrical
- Topside Acc.
- Cockpit & Deck
- Instruments
- Steering, Controls
- Perform.
- Fuel System
- Engine & Parts
- Engine Care
- Propellers
- Seating & Pedestals
- Tops & Covers
- Pumps
- Cleaning & Care
- Paint & Paint Acc.
- Hardware, Fasteners
- Trailering
- Misc.
- Comm.

Johnson Pump Application Guide

Johnson Pump

Johnson Pump Model Number	Engine Application where Applicable	Port Size	Mounting Type	Service Kit	Impeller	End Cover	Wearplate	Cam
F5B-9 (461385) 10-24228-1 (10950-240)	Volvo 431A, 500A/B, 501A, 570A, 571A, AQ180 AQ200, AQ200B/C/D/F, AQ205A, AQ211A AQ225, AQ231A/B, AQ260, AQ255B, AQ260A, AQ271A/B/C/D, AQ280A, AQ290A	3/4"	Flange	09-45808	(462248) 09-1027B (1210-0001)	(462604) 01-45312-1	–	(462755) 05-04-174
F35B-9 10-35-157-3 (29300-2101c)	Volvo MB10A/11, MD1, MD11C/D, MD1A/1B, MD1KHD/HY, MD2, MD2B, MDHBY MD5B/C, MD6A, MD7A/B	3/8"	Flange	09-45589	09-808B	01-43239 (29305-0000)	01-45087 (29306-0000)	01-42679 (ALB)
F7B-9 10-24277-3	Volvo AD31A/B, AD41A/B, AQAD31A, AQD40A, AQD41A, D41A/B, MD31, MD31A, MD40A, TAMD31, TAMD31A, TAMD41, TAMD41A/B, TMD31, TMD31A/B, TMD40A/B/C, TMD41A/B	1"	Flange	09-45592	(462034) 09-1028B (17937-0001)	01-42441 (3993)	–	01-42679 (934)
F4B-9 10-35098-3	Volvo AQ110/115, AQ115A/B, AQ120, AQ120B, AQ125A/B, AQ130, AQ130A/B/C/D, AQ140, AQ60F, BB100, BB115A/B, BB30, MB16A, MB18, MB18F, MB20A/B/C, MD17C/D, MD20B, MD3B	3/8"	Flange	09-45905	09-1026B (18673-0001)	01-45282 (29475-0000)	–	01-42389 (10818)
F6B-9 (461401) 10-24232-1 (22740-0000)	Indmar Marine Power	3/4"	Flange	09-45825	(462250) 09-812B (13554-0001)	(462604) 01-45312-1	–	(462767) 01-45670
F9B-9 (461804) 10-13096-2	Detroit Diesel 653, 671, 853	1-1/2" Flanged	Flange	09-45579	(462050) 09-819B	01-42422-1 (9336)	01-42423 (2574)	01-42680 (834)
F9B-9 (461828) 10-13095-02	Detroit Diesel 671T, 871, 1271	2" Flanged	Flange	0945582	09-814B (17936-0001)	01-42422-1 (9336)	01-42423 (2574)	01-43137 (6988)
F9B-9 10-24239-2 (22040-0501)	Man D2540MLE, D2840LXE/LE401, D2849LE403, D2842LE, D2842LE401/02/06/03/08, D2842LYE/LZE, D2848LE/LXE/LE401/403	2" Flanged	Flange	09-45581	09-802B (17936-0001)	01-42422-1 (9336)	01-42423 (2574)	01-43137 (6988)
F5B-9 10-24140-5	Ford Engines	3/4" NPT	Flange	09-45583	(462248) 09-1027B (1210-0001)	01-42398 (3992)	01-42399 (7883)	01-42397 (490)
F7B-9 10-24139-5	Ford Engines	1" NPT	Flange	09-45590	(462034) 09-1028B (17937-0001)	01-42441 (3993)	01-42443 (4156)	01-42679 (934)
F35B-8007 10-35038-4 3/8" Shaft (2620-1001)	Apollo Diesel, Next Generation	3/8" NPT	Pedestal	09-45589	09-808B	01-43239 (29305-0000)	01-45087 (29306-0000)	01-42415 (29303-0000) (AL8-01)
F35B-8027 10-35038-5 (12mm) metric shaft	Onan, Westerbeke	3/8" NPT	Pedestal	09-45589	09-808B	01-43239 (29305-0000)	01-45087 (29306-0000)	01-42415 (29303-0000) (AL8-01)
F4B-1907 10-24512-3	Multi purpose impeller pump	1/2" NPT 1" Hose	Pedestal	09-46600	09-824P-9	01-42398 (3992)	–	–
F8B-8007**** 10-13021-95 (6400-0004)	Multi purpose impeller pump	1-1/4" NPT	Pedestal	09-45575	(462050) 09-819B	01-42422-1 (9336)	01-42423 (2574)	01-42680 (834)
F7B-8007* (461513) 10-24070-51	Multi purpose impeller pump	1" NPT	Pedestal	09-45592	(462034) 09-1028B (17937-0001)	01-42441 (3993)	–	01-42679 (934)
F7B-5** (461739) 10-24071-17 (11860-0005)	Electric Clutch Pump 12V, 2A Pulley	1" NPT	Pedestal	09-45592	(462034) 09-1028B (17937-0001)	01-42441 (3993)	–	01-42679 (934)
F8B-5*** (461777) 10-13022-33 (50200-2011)	Electric Clutch Pump 12V, 2A Pulley	1-1/4" NPT	Pedestal	09-45575	(462050) 09-819B	01-42422-1 (9336)	01-42423 (2574)	01-42680 (834)

*Replaces Jabsco Model 777-9001

**Replaces Jabsco Model 11860-0005

****Replaces Jabsco Model 11870-0005

****Replaces Jabsco Model 6400-0004

Fun & Flotation

Anchor & Dock

Safety

Electronics

Trolling Motors

Lighting

Electrical

Topside Acc.

Cockpit & Deck

Instruments

Steering, Controls

Perform.

Fuel System

Engine & Parts

Engine Care

Propellers

Seating & Pedestals

Tops & Covers

Pumps

Cleaning & Care

Paint & Paint Acc.

Hardware, Fasteners

Trailer

Misc.

Comm.

Jabsco Clutch Pumps

- Clutch pumps combine the unique advantages of the self-priming flexible impeller Jabsco pump and a clutch-drive mechanism to engage or disengage the pump as needed.
- They are available with either manual or electric clutches for application versatility.
- Generally they are powered by propulsion engines but may be driven by any adequate source of belt drive power.
- Constructed with bronze pump bodies and rotary-mechanical face seals.
- The clutch will "free wheel" with the source of power until the pump is required.
- Then, whenever desired, the clutch can be engaged to throw the pump into operation for emergency of general circulation requirements.
- They are equipped with replaceable brass cam and wearplate to prolong serviceability.
- The removable end cover allows easy impeller replacement without having to remove plumbing or drive belt.
- They are ideal for bilge pumping, livewell circulation, deck washdown and many commercial or pleasure boat general pumping requirements.

Jabsco Electric Clutch Pumps

JABSCO



- The electro-magnetic clutch pumps are equipped with a powerful electric clutch for convenient remote operation.
- Comes with double "A" belt grooves in a 7" diameter pulley.
- Carbon/Ceramic Mechanical Type.

23.3 GPM. 1" IPT.

Order No.	Mfg. No. / Description	Price
417778	(11860-0005) Pump, 12 volt	\$744.98 E
418373	(920-0003-P) Nitrile Impeller	\$41.98 G

62 GPM. 1-1/4" IPT.

Order No.	Mfg. No. / Description	Price
417802	(11870-0005) Pump, 12 volt	\$1,098.98 F
418448	(836-0003-P) Nitrile Impeller	\$57.98 G

83 GPM. 2" IPT.

Order No.	Mfg. No. / Description	Price
417838	(18330-0000) Pump, 12 volt	\$1,502.98 G
418465	(6760-0003-P) Nitrile Impeller	\$189.98 G

Jabsco Manual Clutch Pumps

JABSCO



- The manual clutch pumps are equipped with a mechanically activated clutch that is engaged with the flip of a lever on the pump body.
- Although they require the operator to go to the location of the pump to put it into service, they do provide security of operation in the event of an electrical power failure.

51000-SERIES CLUTCH PUMPS

Order No.	Mfg. No. / Description	Price
417675	(51080-9013) 26 GPM 1" NPT 6" Diameter Pulley	\$1,033.98 G
417698	(51270-9013) 83 GPM 2" NPT 7" Diameter Pulley	\$1,791.98 G

6590-0005 CLUTCH PUMP

- Must rotate in a clockwise direction looking at the end cover.

Order No.	Mfg. No. / Description	Price
417687	(6590-0005) 62 GPM 1-1/4" NPT 6" Diameter Pulley	\$1,598.98 G

Jabsco Impeller Planograms

Jabsco Introductory Impeller Planogram - 9 Pack

JABSCO

- The Impeller Planograms provide a wide array of by displaying Jabsco impellers on shelves in an organized and space reduced fashion.
- Includes: 1210-0001-P, 13554-0001-P, 17018-0001-P, 17935-0001-P, 17937-0001-P, 6056-0003-P, 6303-0003-P, 6303-0007-P, 920-0001-P.

Order No.	Mfg. No. / Description	Price
417250	(18753-5041)	\$460.98 G

Jabsco Aggressive Impeller Planogram - 16 Pack

JABSCO

- The Impeller Planograms provide a wide array by displaying Jabsco impellers on shelves in an organized and space reduced fashion.
- Includes: 1210-0001-P, 13554-0001-P, 17018-0001-P, 17935-0001-P, 17937-0001-P, 6056-0003-P, 6303-0003-P, 6303-0007-P, 920-0001-P, 17936-0001-P, 836-0001-P, 836-0003-P, 18777-0001-P, 18948-0001-P, 22405-0001-P.

Order No.	Mfg. No. / Description	Price
417254	(18753-5043)	\$895.98 G

Jabsco Growth Impeller Planogram - 12 Pack

JABSCO

- The Impeller Planograms provide a wide array by displaying Jabsco impellers on shelves in an organized and space reduced fashion.
- Includes: 1210-0001-P, 13554-0001-P, 17018-0001-P, 17935-0001-P, 17937-0001-P, 6056-0003-P, 6303-0003-P, 6303-0007-P, 920-0001-P, 17936-0001-P, 836-0001-P, 836-0003-P.

Order No.	Mfg. No. / Description	Price
417253	(18753-5042)	\$730.98 G

Jabsco Extreme Impeller Planogram - 21 Pack

JABSCO

- The Impeller Planograms provide a wide array by displaying Jabsco impellers on shelves in an organized and space reduced fashion.
- Includes: 1210-0001-P, 13554-0001-P, 17018-0001-P, 17935-0001-P, 17937-0001-P, 6056-0003-P, 6303-0003-P, 6303-0007-P, 920-0001-P, 17936-0001-P, 836-0001-P, 836-0003-P, 18777-0001-P, 18948-0001-P, 22405-0001-P, 18673-0001-P, 18838-0001-P, 18958-0001-P, 4528-0001-P, 4568-0001-P, 5929-0003-P.

Order No.	Mfg. No. / Description	Price
417256	(18753-5044)	\$1,169.98 G

- Fun & Flotation
- Anchor & Dock
- Safety
- Electronics
- Trolling Motors
- Lighting
- Electrical
- Topside Acc.
- Cockpit & Deck
- Instruments
- Steering, Controls
- Perform.
- Fuel System
- Engine & Parts
- Engine Care
- Propellers
- Seating & Pedestals
- Tops & Covers
- Pumps
- Cleaning & Care
- Paint & Paint Acc.
- Hardware, Fasteners
- Trailering
- Misc.
- Comm.

Jabco Flexible Impellers



- Nitrile.
- Drive type: 4. Blades: 6.
- 1-1/4" D, 15/32" W, Shaft diameter 5/16".

Order No. Mfg. No. / Description Price
415364 (1414-0003-P) Silhouette A **\$32.98** G

- Neoprene.
- Drive type: 7. Blades: 10.
- 2-1/4" D, 1-1/4" W, Shaft diameter 1/2".

Order No. Mfg. No. / Description Price
418562 (3085-0001-P) Silhouette L **\$71.98** G

- Neoprene.
- Drive type: 5. Blades: 12.
- 3-3/4" D, 3-1/2" W, Shaft diameter 1".

Order No. Mfg. No. / Description Price
425492 (17370-0001-P) Silhouette Q **\$127.98** E

- Neoprene.
- Drive type: 4. Blades: 10.
- 2-9/16" D, 2" W, Shaft diameter 3/4".

Order No. Mfg. No. / Description Price
418637 (17954-0001-P) Silhouette Y **\$50.98** G

- Neoprene.
- Drive type: 5. Blades: 12.
- 3-1/16" D, 3" W, Shaft diameter 13/16".

Order No. Mfg. No. / Description Price
415186 (30919-0001) Silhouette Z **\$93.98** G

- Neoprene.
- Drive type: 1 or 2. Blades: 6.
- 1-9/16" D, 3/4" W, Shaft diameter 3/8".

Order No. Mfg. No. / Description Price
418497 (4528-0001-P) Silhouette D **\$42.98** G

- Nitrile.
- Drive type: 3. Blades: 8.
- 2-9/16" D, 2" W, Shaft diameter 5/8".

Order No. Mfg. No. / Description Price
418574 (4598-0003-P) Silhouette M **\$72.98** Q

- Neoprene.
- Drive type: 7. Blades: 12.
- 3-3/4" D, 2-1/2" W, Shaft diameter 1".

Order No. Mfg. No. / Description Price
418424 (17935-0001-P) Silhouette Q **\$72.98** G

- Neoprene.
- Drive type: 6. Blades: 10.
- 2-9/16" D, 2" W, Shaft diameter 5/8".

Order No. Mfg. No. / Description Price
418384 (17956-0001-P) Silhouette Y **\$127.98** G

- Nitrile.
- Drive type: 7. Blades: 12.
- 2-1/4" D, 1-1/4" W, Shaft diameter 5/8".

Order No. Mfg. No. / Description Price
418311 (1210-0003-P) Silhouette K **\$37.98** G

- Nitrile.
- Drive type: 7. Blades: 9.
- 3-3/4" D, 2-1/2" W, Shaft diameter 1".

Order No. Mfg. No. / Description Price
418448 (836-0003-P) Silhouette O **\$57.98** G

- Neoprene.
- Drive type: 3. Blades: 12.
- 2-9/16" D, 1-5/8" W, Shaft diameter 5/8".

Order No. Mfg. No. / Description Price
418664 (18948-0001-P) Silhouette X **\$51.98** G

- Neoprene.
- Drive type: 7. Blades: 10.
- 2-9/16" D, 2" W, Shaft diameter 5/8".

Order No. Mfg. No. / Description Price
418359 (17937-0001-P) Silhouette Y **\$42.98** G

Marpac Impeller Removal Tool



- Fits most impeller makes.
- Won't damage pump.
- Easy to use.
- Stainless steel construction for a lifetime of use.

Order No. Description Price
7-1898 Impeller Removal Tool **\$49.98** G

- Fun & Flotation
- Anchor & Dock
- Safety
- Electronics
- Trolling Motors
- Lighting
- Electrical
- Topside Acc.
- Cockpit & Deck
- Instruments
- Steering, Controls
- Perform.
- Fuel System
- Engine & Parts
- Engine Care
- Propellers
- Seating & Pedestals
- Tops & Covers
- Pumps
- Cleaning & Care
- Paint & Paint Acc.
- Hardware, Fasteners
- Trailer
- Misc.
- Comm.

Jabsco #	DMI #	Description
4436977	417244	PUMP CENTRFLG MAG 11GPM
436979	417246	PUMP CENTRFLG MAG 14GPM
436981	417248	PUMP CENTRFLG MAG 21GPM
02090104	352524	PRESSURE SWITCH/4405
02090118	352500	PRESSURE SWITCH/4325
02840100A	352726	HIGH VOLUME WTR SYSTEM
04105501A	352574	PUMP GENERAL PURPOSE 12V
04325043A	352575	WATER SYSTEM PUMP 45GPM
04325143L	352714	WASHDOWN PUMP KIT 12V
04405143A	352702	12V WATER PRESS PUMP
04405443A	352738	32V WATERPRESS PUMP 1/2
11810-0003	417459	AC MOTOR PUMP 9.5GPM
11830-0000	418702	END COVER 3/8"
11831-0000	418725	END COVER 1"
11860-0005	417778	CLUTCH PUMP 12V 1"
11870-0005	417802	CLCH PMP 12V 1-1/4"
11979-0001-P	418599	IMPELLER
12062-0000	418738	END COVER 1-1/4"-2"
1210-0001-P	418309	IMPELLER
1210-0003-P	418311	IMPELLER
12210-0003	417407	AC MOTOR PUMP 3.4GPM
1414-0003-P	415364	OIL CHANGER IMPELLER
14750-0001	418233	IMPELLER
14750-0003-P	418246	IMPELLER
14780-0001	413601	QUARTZ FLOODLIGHT
15294-1010	425593	WEAR RING (VORTEX)
15295-1010	425606	SHAFT (VORTEX)
15296-1000	425579	WEAR PLATE KIT (VORTEX)
15297-1010	425581	CAM WEAR KIT (VORTEX)
15780-0000	418120	CUMMINS VORTEX PUMP
16731-001	417902	1/2" ENG PUMP 11.3 GPM
17215-0000	415275	DRILL PUMP KIT
17250-0003	415287	DRILL PUMP
17255-0003-P	415353	DRILL PUMP IMPELLER
17360-1001	423587	2" G.M. REPLACEMENT PUMP
17365-1000	425517	GASKET END COVER
17366-1000	425668	SHAFT
17370-0001-P	425492	IMPELLER
17372-1000	425531	WEAR PLATE
17374-1000	425529	CAM LINER
17800-2000	415326	OIL CHANGER UNIT
17850-1012	415338	DIY OIL CHANGER
17860-2012	415340	OIL CHANGER FLAT TANK
17890-0000	415302	OIL ABSORBER PAD
17935-0001-P	418424	IMPELLER
17936-0001-P	418457	IMPELLER
17937-0001-P	418359	IMPELLER
17954-0001-P	418637	47-59362 MERC IMPELLER
17956-0001-P	418384	IMPELLER
18080-0000	415299	DRAIN KIT
18220-1127	417040	MPU BALLAST W/PUPPY
18220-9127	417041	BALLAST PPY W/DEUTSCH
18330-0000	417838	CLUTCH PUMP 12V 2"
18370-0000	417976	ENG PUMP 83 GPM
18590-2092	415154	MACERATOR 12V RUNDRY
18598-1000	415162	MACERATOR SERVICE KIT
18610-0003	417422	AC PUMP 5.8GPM
18660-0121	417217	12V WATER PUPPY 6.3GPM
18670-0123	417243	12VHD WATER PUPPY 7.8GPM
18673-0001-P	418500	IMPELLER
18680-1000	417053	12V PUMP 5GPM
18685-0000	414463	115V FUEL TRANSFER PUMP
18690-0000	415174	HD MACERATOR 110V
18721-0000	425567	RETAINING RING/SEAL
18753-0178	413067	BULB FOR 135SL LIGHT
18753-0336	413079	BULB FOR 255SL LIGHT
18753-0455	413081	BULB FOR 146SL LIGHT
18753-0525	425911	SHAFT
18753-5041	417250	IMPELLER PLANOGRAM 9PK
18753-5042	417253	IMPELLER PLANOGRAM 12PK
18753-5043	417254	IMPELLER PLANOGRAM 16PK
18753-5044	417256	IMPELLER PLANOGRAM 21PK
18770-0003	418106	CUMMINS K19 125GPM 2-HOL
18784-2000	425860	END COVER
18785-0000	425858	LINER/O RING
18786-0001-W	418625	IMPELLER KIT
18787-0000	425872	WEAR PLATE

Jabsco #	DMI #	Description
18789-0001	425834	IMPELLER
18810-0000	414641	PRESSURE TANK
18838-0001-P	423361	SHERWOOD IMPELLER
18940-0010	418078	1-1/4" SHERWOOD PUMP
18948-0001-P	418664	10615 SHERWOOD IMPELLER
18958-0001-P	418613	IMPELLER
2235-0000	416467	WEAR PLATE
2574-0000	416594	WEAR PLATE
2620-1101	417898	3/8" ENG PUMP 5.8 GPM
29045-0000	414920	TOILET SRV KIT PRE '97
29045-2000	414932	TOILET SRV KIT AFT 1997
29090-3000	414906	COMPACT MANUAL TOILET
30002-0000	416215	VALVE KIT
30016-0000	416288	DIAPHRAGM KIT
30021-0000	416176	BELT KIT
30022-0000	416188	BELT KIT
30124-0000	416026	SERVICE KIT
30200-0000	416138	12V D.C. MOTOR KIT
3085-0001-P	418562	IMPELLER
30919-0001	415186	IMPELLER
31295-0092	418084	WATER PUMP PAR MAX 6.0
31395-0092	414603	PARMAX PRESS PUMP 2.9GPM
31395-0094	414480	PUMP S/E 2.9GPM 24V
31620-0092	414490	PARMAX PUMP 4.5GPM 12V
31705-0092	414817	BILGE/LVWELL PUMP
3181-0000	416912	SLINGER 1-1/4"
32600-0092	414487	PARMAX PUMP 3.5GPM 12V
32605-0092	414628	WASHDOWN PUMP 4.0
32900-0092	414780	WASHDN KIT 4.0GPM W/HOSE
3298-0000	416998	GASKET
33799-0000	415251	PUMP
34060-0010	415249	PUMP
34060-0130	415237	PUMP-HAND OIL DRAIN
34344-0000	414689	CHECK VALVE
34744-0000	413904	BLOWER 115V AC
35115-0020	413916	105 CFM FLNG BLOWER 12V
35400-0000	413966	250 CFM FLNG BLOWER 12V
35515-0010	414019	105 CFM FLEX BLOWER 12V
36200-0000	414350	PUMP GUARD 3/4"
36400-0000	414754	PUMPGARD 1/2"
36600-0000	414261	BILGE PUMP 12V 8GPM
36680-2000	414235	BILGE PUMP 12V 5.5GPM
36740-0000	414021	150 CFM FLEX BLOWER 12V
36800-1000	414526	WATER PRESSURE SYS 12V
36950-2000	414499	WATER PRESSURE SYS 12V
36960-2000	414211	BILGE PUMP 12V 4GPM
37010-0090	414956	TOILET COMPACT 12V
37010-0092	415085	12V TOILET CONV KIT
37010-1090	414970	HOUSEHOLD 12V HEAD
37040-0000	415011	SERVICE KIT FOR 37010
37041-0010	415023	REPLACEMENT PUMP ASSY
37064-0000	415035	REPL 12V MOTOR
37121-0010	425721	PRESSURE SWITCH
4156-0000	423119	WEAR PLATE/1"
4156-0010	423121	WEAR PLATE
42510-0000	414398	PLASTIC WATER PUMP
42530-0000	414401	COMB PUMP/FAUCET
42630-3992-P	417252	FAUCET PUMP KIT 12V
42755-0092	414701	VFL0 VAR SPEED PMP 5.0
43670-0003	413245	MAIN CONTROL
43670-0004	413257	SECONDARY CONTROL KIT
43990-0014	413269	15' WIRING CABLE ASSY
44411-0045	414716	INLINE WTR PRS RGLTR 3/4
44412-1045	414704	FLSH WTR PRES RGLTR 1/2"
4528-0001-P	418497	IMPELLER
45490-1000	415201	Y VALVE
45900-0000	413500	FLOODLIGHT 4X6 12V/72656
45900-1000	413512	FLOODLIGHT 3X5 12V/73620
45903-0000	413550	4X6 12V BULB
45903-0002	413562	3X5 12V BULB
4598-0003-P	418574	IMPELLER
490-0001	423195	BRASS CAM
50070-0200	418221	IMPELLER PULLER
50840-0012	417027	PUMP CNTRFGL SS 3/4" NPT
50890-1000	415136	PUMP WASTE EVACUATION
50900-1000	414831	PUMP FISH BOX EVACUATION
51080-9013	417675	CLUTCH PUMP 1"

Jabsco #	DMI #	Description
51270-9013	417698	MAN CLUTCH PUMP 2"
58020-1012	414982	TOILET DELUXE FLUSH 12V
5850-0001	418093	OEM COOLING PUMP
5929-0001-P	418335	IMPELLER
5929-0003-P	418347	IMPELLER
60010-2012	412647	SEARCHLIGHT 12V 255SL
60020-0000	412609	SEARCHLIGHT 12V 135SL
60030-0000	413395	DUAL STATN CNTRL/60020
60080-0012	412623	SEARCHLIGHT 12V 146SL
6050-0003	417507	MOTOR PUMP 26GPM
6056-0003-P	418412	IMPELLER
6065-0003	417511	PUMP HEAD
61050-0012	412611	SEARCHLIGHT 12V 155SL
6303-0001-P	418284	IMPELLER
6303-0003-P	418295	IMPELLER
6303-0007-P	418285	IMPELLER KIT POS
6303-007-P	418420	IMPELLER BALLAST PUPPY
6398-0000	423222	SLINGER BAG OF 3
6400-0004	417953	1-1/4" ENG PUMP 62 GPM
6400-1051	417954	1-1/4" ENG PUMP 62GPM SS
64042-1008	413423	EXTENSION CABLE 25'
64046-0006	413051	SPOT/FLOOD BULB & SEAL
6407-0010	423234	SEAL
6408-0000	423246	SEAL
6590-0005	417687	MAN CLUTCH PUMP 1-1/4"
67262-0000	413043	12V 7" BULB
6760-0003-P	418465	IMPELLER
6988-0000	423272	CAM
7273-0001-P	418524	IMPELLER
7273-0003-P	418536	IMPELLER
7420-0004	417964	1-1/4" ENG PUMP 62 GPM
777-9001	417940	ENGINE PUMP 1" 26GPM
7867-0000	423296	BRASS CAM PUMP
7869-0000	423309	CAM/PLATE ASSEMBLY
7884-0000	423323	CAM/WEAR PLATE ASSEMBLY
816-0000	418888	EC GASKET 1-1/4"-2"
817-0000	423335	BEARING SEAL/1-1/4
818-0000	423347	SEAL
824-0020	423359	SS SHAFT
82500-0092	418080	WATER PUMP PAR MAX 5.0
82505-0092	414629	WASHDOWN PUMP KIT 5.0
82600-0092	418082	WATER PUMP PAR MAX 6.0
82605-0092	414630	WASHDOWN PUMP KIT 6.0
834-0001	423373	BRASS CAM 1-1/4
836-0001-P	418435	IMPELLER
836-0003-P	418448	NITRILE IMPELLER
890-0000	418878	EC GASKET 1"
90058-0003	423688	SERVICE KIT
90071-0001	425810	MINOR SERVICE KIT
90200-0000	416820	SERVICE KIT F/45710 PUMP
90202-0000	425825	MNR SRV KT CUMMINS VORTX
91002-0020	423385	SCREW 3PK
91003-0010	423397	END COVER SCREW 3-PK
91004-0090	423400	CAM SCREW 3-PK
91005-0040	423412	CVR/CAM SCREW 3-PK
913-0000	423424	INNER BEARING SEAL/1"
920-0001-P	418361	IMPELLER
9200-0023-P	418601	IMPELLER KIT FOR 17800
920-0003-P	418373	IMPELLER
92300-0030	423664	CLUTCH ASSEMBLY 12V
92600-0060	423462	BEARING
92700-0060	423498	1" LIP SEAL
92700-0080	423501	SEAL
92700-0420	423513	SEAL
92701-0180	416803	SEAL
934-0000	423537	BRASS CAM
96080-0080	423549	FACE SEAL 1"
96080-0371	425555	WATER SEAL
98022-0500	423640	FIELD COIL 12V

- Fun & Flotation
- Anchor & Dock
- Safety
- Electronics
- Trolling Motors
- Lighting
- Electrical
- Topside Acc.
- Cockpit & Deck
- Instruments
- Steering, Controls
- Perform.
- Fuel System
- Engine & Parts
- Engine Care
- Propellers
- Seating & Pedestals
- Tops & Covers
- Pumps
- Cleaning & Care
- Paint & Paint Acc.
- Hardware, Fasteners
- Trailering
- Misc.
- Comm.









Donovan #	Impeller #	Drive Material	Type	No. of Blades	Diameter	Width	Shaft Dia.	Insert Material	Remarks
Silhouette A									
	1414-0001	Neoprene	4	6	1-1/4"	15/32"	5/16"	BR	
415364	1414-0003P	Nitrile	4	6	1-1/4"	15/32"	5/16"	BR	
	12104-0001	Neoprene	2	6	1-1/4"	15/32"	5/16"	BR	Onan (Use 6-32 x 5/8 Hdl's Screw)
	21414-0001	Neoprene	4	6	1-1/4"	15/32"	5/16"	BR	
Silhouette B									
418233	14750-0001P	Neoprene	4	8	1-1/4"	15/32"	5/16"	BR	
418246	14750-0003P	Nitrile	4	8	1-1/4"	15/32"	5/16"	BR	
Silhouette C									
	14609-0001	Neoprene	4	6	1-1/4"	15/32"	5/16"	BR	
	14609-0003	Nitrile	4	6	1-1/4"	15/32"	5/16"	BR	
	14787-0001	Neoprene	4	6	1-1/4"	15/32"	5/16"	PL	Was SS Insert
	14787-0003	Nitrile	4	6	1-1/4"	15/32"	5/16"	PL	Was SS Insert
Silhouette D									
418497	4528-0001P	Neoprene	1 or 2	6	1-9/16"	3/4"	3/8"	BR	Was AL -24
	4528-0003	Nitrile	1 or 2	6	1-9/16"	3/4"	3/8"	BR	Was AL -24 - 37
415353	17255-0003P	Nitrile	-	6	1-9/16"	3/4"	1/4"	None	Impeller Molded on Shaft
	22405-0001	Neoprene	1	6	1-9/16"	3/4"	15/32"	BR	
Silhouette F									
	9200-0001	Neoprene	4	10	1-19/32"	3/4"	5/16"	PL	Was Brass Insert
	9200-0003	Nitrile	4	10	1-19/32"	3/4"	5/16"	PL	Was Brass Insert
	9200-0021	Neoprene	4	10	1-19/32"	3/4"	5/16"	BR	
	9200-0023	Nitrile	4	10	1-19/32"	3/4"	5/16"	BR	
Silhouette G									
	653-0001*	Neoprene	1	6	2"	7/8"	15/32"	BR	
	673-0001*	Neoprene	1 or 2	6	2"	7/8"	1/2"	BR	
	673-0003*†	Nitrile	1 or 2	6	2"	7/8"	1/2"	BR	
	4527-0001	Neoprene	2	6	2"	7/8"	5/16"	None	Was B-12
	4527-0003	Nitrile	2	6	2"	7/8"	5/16"	None	Was B-12
	5616-0001	Neoprene	6	6	2"	7/8"	1/2"	BR	Brass Extended Drive Cup
	5616-0003	Nitrile	6	6	2"	7/8"	1/2"	BR	
418524	7273-0001P	Neoprene	4	6	2"	7/8"	5/16"	PL	
418536	7273-0003P	Nitrile	4	6	2"	7/8"	5/16"	PL	
	22799-0001	Neoprene	3	6	2"	7/8"	1/2"	BR	
Silhouette H									
418284	6303-0001P	Neoprene	4	6	2"	7/8"	5/16"	PL	
418295	6303-0003P	Nitrile	4	6	2"	7/8"	5/16"	PL	
	17486-0001	Neoprene	6	6	2"	7/8"	1/2"	BR	Brass Extended Drive Cup
Silhouette I									
	18653-0001*	Neoprene	1	10	2"	7/8"	15/32"	BR	Johnson 810 B
418500	18673-0001P*	Neoprene	1 or 2	10	2"	7/8"	1/2"	BR	
	18673-0003*	Nitrile	1 or 2	10	2"	7/8"	1/2"	BR	
Silhouette K									
418309	1210-0001P	Neoprene	7	12	2-1/4"	1-1/4"	5/8"	BR	
418311	1210-0003P	Nitrile	7	12	2-1/4"	1-1/4"	5/8"	BR	
	4568-0001	Neoprene	3	12	2-1/4"	1-1/4"	5/8"	BR	Replaces C-12
418335	5929-0001P	Neoprene	6	12	2-1/4"	1-1/4"	1/2"	BR	SS Extended Drive Cup
418347	5929-0003P	Nitrile	6	12	2-1/4"	1-1/4"	1/2"	BR	SS Extended Drive Cup
	13554-0001	Neoprene	7	12	2-1/4"	1-29/32"	5/8"	BR	Johnson 812 B
	14281-0001	Neoprene	5	12	2-1/4"	1-1/4"	5/8"	PL	
	22120-0001	Neoprene	7	12	2-1/4"	2"	5/8"	BR	Volvo V-8
Silhouette L									
418562	3085-0001P	Neoprene	7	10	1/2"	1-1/4"	5/8"	BR	
	18815-0005	Neoprene	6	10	1/2"	1-1/4"	1/2"	BR	SS Extended Drive Cup (Sanitary)

- Fun & Flotation
- Anchor & Dock
- Safety
- Electronics
- Trolling Motors
- Lighting
- Electrical
- Topside Acc.
- Cockpit & Deck
- Instruments
- Steering, Controls
- Perform.
- Fuel System
- Engine & Parts
- Engine Care
- Propellers
- Seating & Pedestals
- Tops & Covers
- Pumps
- Cleaning & Care
- Paint & Paint Acc.
- Hardware, Fasteners
- Trailer
- Misc.
- Comm.

*653-Series impellers are not interchangeable with 673-Series and 18653-Series impellers are not interchangeable with 18673-Series.
 †673-Series impellers may be replaced with the newer 18673-Series.

Donovan #	Impeller #	Drive Material	Type	No. of Blades	Diameter	Width	Shaft Dia.	Insert Material	Remarks
Silhouette M									
418361	920-0001P	Neoprene	7	8	2-9/16"	2"	5/8"	BR	
418373	920-0003P	Nitrile	7	8	2-9/16"	2"	5/8"	BR	
	920-0008†	Natl. Rub.	7	8	2-9/16"	2"	5/8"	BR†	For Low Temp. to 27° F - Max. 120° F
	4598-0001	Neoprene	3	8	2-9/16"	2"	5/8"	BR	Was D-12
418574	4598-0003P	Nitrile	3	8	2-9/16"	2"	5/8"	BR	Was D-12-37
418412	6056-0003P	Nitrile	6	8	2-9/16"	2"	5/8"	BR	SS Extended Drive Cup
418599	11979-0001P	Neoprene	7	8	2-9/16"	1-7/16"	5/8"	BR	
	17018-0001	Neoprene	7	8	2-9/16"	3"	5/8"	BR	
Silhouette O									
418435	836-0001P	Neoprene	7	9	3-3/4"	2-1/2"	1"	BR	
418448	836-0003P	Nitrile	7	9	3-3/4"	2-1/2"	1"	BR	
	836-0008†	Natl. Rub.	7	9	3-3/4"	2-1/2"	1"	BR†	
	6760-0001	Neoprene	7	9	3-3/4"	3-1/2"	1"	BR	
418465	6760-0003P	Nitrile	7	9	3-3/4"	3-1/2"	1"	BR	
	6760-0008†	Natl. Rub.	7	9	3-3/4"	3-1/2"	1"	BR†	
Silhouette Q									
425492	17370-0001P	Neoprene	5	12	3-3/4"	3-1/2"	1"	PL	
418424	17935-0001P	Neoprene	7	12	3-3/4"	3-1/2"	1"	BR	Alternative to 836-0001
418457	17936-0001P*	Neoprene	7	12	3-3/4"	3-1/2"	1"	BR	Alternative to 6760-0001
	21676-0003	Neoprene	7	12	3-3/4"	3-1/2"	1"	BR	U.K. Equivalent to 17936-0001
Silhouette R									
	17240-0001	Neoprene	7	9	4-5/8"	3-1/2"	1"	BR	
	18786-0001	Neoprene	5	9	4-5/8"	3-1/2"	1"	PL	
	18789-0001	Neoprene	7	9	4-5/8"	3-1/2"	1"	BR	Replaces UK 17240-0001
Silhouette U									
	2999-0001	Neoprene	7	13	5"	4"	1-1/2"	BR	
Silhouette W									
423361	18838-0001P	Neoprene	3	12	2-7/16"	1-1/4"	5/8"	BR	Replaces Sherwood 9959 Impeller
Silhouette X									
418664	18948-0001P	Neoprene	3	12	2-9/16"	1-5/8"	5/8"	BR	Replaces Sherwood 10615 Imp.
Silhouette Y									
418359	17937-0001P	Neoprene	7	10	2-9/16"	2"	5/8"	BR	Replaces 920-0001
	17937-0003	Nitrile	7	10	2-9/16"	2"	5/8"	BR	
418637	17954-0001P	Neoprene	4	10	2-9/16"	2"	3/4"	BR	MerCruiser Replacement
418384	17956-0001P	Neoprene	6	10	2-9/16"	2"	5/8"	BR	SS Drive Cup, Replaces 6056-0001
	18327-0001	Neoprene	3	10	2-9/16"	2"	5/8"	BR	Replaces Sherwood 15000 Impeller
Silhouette Z									
415186	30919-0001P	Neoprene	5	12	3-1/16"	3"		BR	
Silhouette CC									
	31130-0061	Neoprene	7	10	2-19/32"	2-11/16"	5/8"	R	MerCruiser Replacement (HINO) (Replaces Quicksilver 47-831311350)
Silhouette GG									
418613	18958-0001P	Neoprene	3	12	3-1/4"	2-57/64"	25/32"	BR	Replaces Sherwood 17000 Impeller

† = For Low Temp. to 27° F Max. 120° F
 * = The 17936-0001 Impeller may be used to replace an English Model 21676-0001.

Drive Type	
1 SLOTTED SHAFT PIN DRIVE 	5 DOUBLE FLAT DRIVE 
2 THROUGH HOLE PIN DRIVE 	6 DING DRIVE KEYWAY 
3 KEY DRIVE 	7 SPLINE DRIVE 
4 SINGLE FLAT DRIVE 	8 RIBBED SEGMENT KEY 

-  Fun & Flotation
-  Anchor & Dock
-  Safety
-  Electronics
-  Trolling Motors
-  Lighting
-  Electrical
-  Topside Acc.
-  Cockpit & Deck
-  Instruments
-  Steering, Controls
-  Perform.
-  Fuel System
-  Engine & Parts
-  Engine Care
-  Propellers
-  Seating & Pedestals
-  Tops & Covers

Pumps

-  Cleaning & Care
-  Paint & Paint Acc.
-  Hardware, Fasteners
-  Trailering
-  Misc.
-  Comm.

Jabsco Service Parts



Order No.	Mfg. No. / Description	Price
416176	(30021-0000) Belt Kit	\$27.98 G
416188	(30022-0000) Belt Kit	\$25.98 G
416215	(30002-0000) Valve Kit	\$63.98 F
416288	(30016-0000) Diaphragm Kit	\$50.98 F
416467	(2235-0000) Wear Plate	\$15.98 G
416594	(2574-0000) Wear Plate	\$27.98 G
416803	(92701-0180) Seal	\$15.98 G
416820	(90200-0000) Service Kit for 45710 Pump	\$61.98 F
416912	(3181-0000) Slinger 1-1/4"	\$15.98 G
416998	(3298-0000) Gasket	\$11.98 G
417511	(6065-0003) Pump Head	\$660.98 G
418625	(18786-0001-W) Impeller Kit	\$190.98 G
418702	(11830-0000) End Cover 3/8"	\$17.98 G
418738	(12062-0000) End Cover 1-1/4 - 2	\$91.98 G
418878	(890-0000) End Cover Gasket 1	\$5.98 Q
423119	(4156-0000) Wear Plate/1	\$18.98 G
423121	(4156-0010) Wear Plate	\$28.98 G
423195	(490-0001) Brass Cam	\$37.98 F
423222	(6398-0000) Slinger, Bag of 3	\$29.98 F
423234	(6407-0010) Seal	\$70.98 F
423296	(7867-0000) Brass Cam	\$44.98 F
423309	(7869-0000) Cam/Plate Assembly	\$55.98 F
423323	(7884-0000) Cam/Wear Plate Assembly	\$49.98 F
423335	(817-0000) Bearing Seal 1-1/4"	\$28.98 F
423347	(818-0000) Seal	\$40.98 F
423359	(824-0020) Stainless Steel Shaft	\$362.98 LQ
423361	(18838-0001-P) Flexible Impeller	\$42.98 F
423373	(834-0001) Brass Cam 1-1/4"	\$57.98 F
423385	(91002-0020) Screw, 3 Pack	\$15.98 F
423397	(91003-0010) End Cover Screw, 3 Pack	\$14.98 F
423400	(91004-0090) Cam Screw, 3 Pack	\$8.98 F

- Fun & Flotation
- Anchor & Dock
- Safety
- Electronics
- Trolling Motors
- Lighting
- Electrical
- Topside Acc.
- Cockpit & Deck
- Instruments
- Steering, Controls
- Perform.
- Fuel System
- Engine & Parts
- Engine Care
- Propellers
- Seating & Pedestals
- Tops & Covers
- Pumps
- Cleaning & Care
- Paint & Paint Acc.
- Hardware, Fasteners
- Trailer
- Misc.
- Comm.

Order No.	Mfg. No. / Description	Price
423412	(91005-0040) CVR/Cam Screw, 3 Pack	\$7.98 F
423424	(913-0000) Inner Bearing Seal/1	\$19.98 F
423462	(92600-0060) Bearing	\$115.98 F
423498	(92700-0060) 1 Lip Seal	\$26.98 F
423501	(92700-0080) Seal	\$59.98 F
423513	(92700-0420) Seal	\$28.98 F
423537	(934-0000) Brass Cam	\$31.98 F
423549	(96080-0080) Face Seal 1	\$67.98 F
423587	(17360-1001) Engine Cooling Pump	\$2,764.98 G
423640	(98022-0500) Field Coil, 12 volt	\$191.98 G
423664	(92300-0030) Clutch Assembly, 12 volt	\$383.98 G
423688	(90058-0003) Service Kit	\$165.98 F
425517	(17365-1000) Gasket End Cover	\$20.98 LQ
425529	(17374-1000) Cam Liner	\$246.98 F
425531	(17372-1000) Wear Plate	\$94.98 F
425555	(96080-0371) Water Seal	\$94.98 F
425567	(18721-0000) Retaining Ring/Seal	\$20.98 F
425579	(15296-1000) Wear Plate Kit (Vortex)	\$583.98 F
425581	(15297-1010) Cam Wear Kit (Vortex)	\$569.98 F
425593	(15294-1010) Wear Ring (Vortex)	\$426.98 F
425606	(15295-1010) Shaft (Vortex)	\$510.98 F
425668	(17366-1000) Shaft	\$913.98 F
425810	(90071-0001) Minor Service Kit	\$468.98 LQ
425825	(90202-0000) Minor Service Kit Cummins Vortex	\$979.98 G
425834	(18789-0001) Impeller	\$231.98 F
425858	(18785-0000) Liner/O Ring	\$252.98 F
425860	(18784-2000) End Cover	\$470.98 F
425872	(18787-0000) Wear Plate	\$233.98 F
425911	(18753-0525) Shaft	\$344.98 F
418221	(50070-0200) Impeller Puller	\$141.98 G

Jabsco Cyclone Centrifugal Pump - Stainless Steel



- Heavy duty robust stainless steel construction.
- Virtually silent running.
- 3,500 hour long life DC motor.
- Rotatable head 90°.
- Anti-clog impeller design.
- NPT and BSP ports available for global markets.
- Long life mechanical seal.
- Typical applications would be for circulation applications such as hot water systems, livewell or bait tank installations.
- 3/4" NPT.
- 12 volt.

Order No.	Mfg. No. / Description	Price
417027	(50840-0012)	\$305.98 F

SERVICE PARTS

Order No.	Mfg. No. / Description	Price
418725	(11831-0000) End Cover 1"	\$28.98 G
418738	(12062-0000) End Cover 1-1/4" - 2"	\$91.98 G
418878	(890-0000) EC Gasket 1"	\$5.98 Q
418888	(816-0000) EC Gasket 1-1/4" - 2"	\$10.98 Q
423246	(6408-0000) Seal	\$73.98 F
423272	(6988-0000) Cam	\$67.98 F

Jabsco Water Puppy - Flexible Impeller Pumps



WATER PUPPY

- Continuously rated duty bilge/sump pump.
- 6.3 GPM @ 10' Head.
- Self-priming up to 4' vertical lift.
- Connections for 1/2" NPT male threaded fittings and for 1" ID hose.
- 12 volt.

Order No.	Mfg. No. / Description	Price
417217	(18660-0121)	\$205.98 G
418284	(6303-0001-P) Neoprene Impeller, 6 Blades	\$28.98 G

COMMERCIAL DUTY WATER PUPPY

- High flow, continuously rated bilge pump offering good discharge head.
- 7.8 GPM @ 10' Head.
- Bilge debris presents no problem to this bronze bodied, flexible impeller design.
- Self-priming up to 8' vertical lift.
- Connections for 1/2" NPT male threaded fittings and for 1" ID hose.
- 12 volt.

Order No.	Mfg. No. / Description	Price
417243	(18670-0123)	\$336.98 Q
418295	(6303-0003-P) Nitrile Impeller, 6 Blades	\$28.98 G

Jabsco Reversible Vane Pump



- Ideal for transferring diesel fuel.
- Self-priming to about three feet and can pump against a discharge head of up to twenty feet.
- Flow rate: 6 GPM.
- With its integral on-off reversing switch, it is ideal for moving fuel between port and starboard fuel tanks.
- Port type: 1/2" NPT female or 1" hose barb.
- Duty cycle: 30 minutes at 10' at 86° F (30° C).
- 12 volt.



Order No.	Mfg. No. / Description	Price
417053	(18680-1000)	\$377.98 F

Jabsco Vane Pump



- Ideal for pumping light oil or transferring diesel fuel.
- Flow rate: 7.9 GPM.
- Self-priming with a suction lift of up to five feet and can pump against a discharge head of up to twenty feet.
- Continuous duty - 30 minutes maximum.
- Port type: 1/2" NPT female or 1" hose barb.
- 6' power cord.
- ISO 9097, USCG 183.410 Complaint ignition protected.
- 115V AC.



Order No.	Mfg. No. / Description	Price
414463	(18685-0000)	\$712.98 Q

Johnson Pump Reversible Impeller Oil Change Pump



- Reversible rubber impeller pump with integrated quick reversing switch.
- Designed to remove old oil from the engine/fill new oil back into the engine.
- 5.5 GPM.
- Connection 3/8" NPT.
- Lip seal.
- Impeller: 09-843S-9.
- 12 volt.



Order No.	Mfg. No. / Description	Price
462000	(10-24760-03) F3B-19	\$291.98 Q
462329	(09-45595) Service Kit	\$49.98 G

Johnson PumpGear Pump with Oil Change Kit



- Can run dry!
- Light and compact oil change pump with pump body and gears made of PTFE.
- In cold weather, the gears move the oil more easily than impeller pumps.
- Comes complete with oil dip stick, extraction tube, connection wires with battery clamps.
- Self priming: Up to 3.28 feet.
- Capacity 2.11 GPM



Order No.	Mfg. No. / Description	Price
470090	(80-47508-01) 12 volt	\$165.98 G
470091	(80-47508-02) 24 volt	\$165.98 G

Groco Gear Pumps



- Self-priming, are instantly reversible, and are capable of operation in either direction.
- Relatively low flow (less than vane pumps) makes them suitable for duties such as deck-wash, fuel transfer, ballast transfer and oil change.
- All models have an ignition protected motor and #316 stainless steel shaft, and are available in models that provide reversing (R), remote reversing (RR),and reversing with touchpad (RT) control options.
- 3/8" NPT.
- Note: Do not pump gasoline or other explosive liquids.



Order No.	Mfg. No. / Description	Price
S/O	(GPB-1) Control Type Included: None	POR
S/O	(GPBR-1) Control Type Included: Pump Mounted Reversing Switch	POR
S/O	(GPRR-1) Control Type Included: Remote Momentary Reversing Rocker Switch	POR

Groco Flo-Master SPO-60 Series Vane Pumps



- Oil pumping, diesel fuel pumping, bilge pumping and deckwash.
- Mounts in any position.
- Self-priming to 24".
- Continuous duty face-type shaft seal.
- Ignition protected permanent magnet ball bearing motor.
- Delrin rotor and blades are not affected by exposure to diesel fuel or crankcase oil.
- Optional reversing switch allows pumping in either direction.
- Ports are threaded externally for garden hose and internally for 1/2" NPT.
- 12 volt. 24 and 32 volt available.
- Note: Do not pump gasoline or other explosive liquids.



Order No.	Mfg. No. / Description	Price
375181	(SPO-60-N 12V) Non-Reversing 7 GPM	\$397.98 R
375177	(SPO-60-R 12V) Reversing 7 GPM	\$597.98 R

Groco U-Lube Oil Change Systems



- At the heart of GROCO's U-Lube systems is a powerful gear pump that delivers an honest 3-plus GPM.
- All models have dry-run protection, touchpad control, a plumbing schematic to tell you what hose goes where, and a handy maintenance log.
- G-3 is covered (except for the valves), for a clean engine room appearance, and offers a compact mount footprint. Touch-pad control and over-current protection are cover-mounted.
- G-6 is covered (except for the valves), and offer a slim mount footprint. Touch-pad control and over-current protection are cover-mounted.



Order No.	Mfg. No. / Description	Price
S/O	(G-3) 3-Port	Price on Request
S/O	(G-6) 6-Port	Price on Request

- Fun & Flotation
- Anchor & Dock
- Safety
- Electronics
- Trolling Motors
- Lighting
- Electrical
- Topside Acc.
- Cockpit & Deck
- Instruments
- Steering, Controls
- Perform.
- Fuel System
- Engine & Parts
- Engine Care
- Propellers
- Seating & Pedestals
- Tops & Covers
- Pumps**
- Cleaning & Care
- Paint & Paint Acc.
- Hardware, Fasteners
- Trailering
- Misc.
- Comm.

Jabco Flexible Impeller AC Motor Pumps

- Self-priming and portable.
- Equipped with AC electric motors.
- These pumps are suitable for almost any circulation or washdown applications.

Jabco 12210 Series Flexible Impeller AC Motor Pump



- Compact model.
- Intermittent duty cycle.
- 3.4 GPM @ 10' head.
- Motor: 1/12 HP.
- The motor has replaceable brushes for extended life.
- 3/8" NPT internal thread and adapters for 3/4" garden hose thread.
- 6' power cord with grounded plug.
- 115V AC.

Order No.	Mfg. No. / Description	Price
417407	(12210-0003) Pump	\$531.98 G
418233	(14750-0001) Impeller Neoprene, 8 Blades	\$38.98 G
418246	(14750-0003-P) Impeller Nitrile, 8 Blades	\$36.98 G

Jabco 11810 Series Flexible Impeller AC Motor Pump



- A midrange model.
- Continuous duty motor with thermal over-load protection.
- 9.5 GPM @ 10' head.
- Motor: 1/3 HP.
- Open drip proof motor.
- It has a replaceable wearplate to extend serviceability when handling abrasive fluids.
- Will accept the optional Vacuum Switch (4732-0000) to automatically shut off the pump and prevent dry running.
- 1/2" NPT internal thread. 3/4" Garden Hose Thread OD.
- 8' power cord with grounded plug.
- 115V AC.

Order No.	Mfg. No. / Description	Price
417459	(11810-0003) Pump	\$767.98 F
418335	(5929-0001-P) Impeller Neoprene, 12 Blades	\$109.98 G
418347	(5929-0003-P) Impeller Nitrile, 12 Blades	\$106.98 G

Jabco Ballast Puppy - Wakeboard Towboat Ballast Pump



- Includes Run-dry impeller.
- 9 GPM (34 LPM) flow rate.
- Self-priming to 3 ft.
- Ballast Puppy adds approximately 80 pounds of ballast water per minute.
- Reversible pumps both fills and empties ballast tanks.
- Available with or without Reversing Polarity Switch to fill or empty ballast tanks.
- Complies with USCG 183.410 and ISO 8846 MARINE (Ignition Protected).

Order No.	Mfg. No. / Description	Price
417040	(18220-1127) Pump, Reversing Switch Included	\$326.98 F
417041	(18220-9127) Pump, Deutsch Conn., No Reversing Switch	\$317.98 G
418285	(6303-0007-P) Impeller - Green Polyurethane	\$47.98 G
418420	(6303-007-P) Replacement Impeller	\$47.98 G

Jabco 18610 Series Flexible Impeller AC Motor Pump



- A midrange model.
- Continuous duty motor with thermal over-load protection.
- 5.8 GPM @ 10' head.
- Motor: 1/6 HP.
- 1/2" NPT internal thread. 1" hose barbed OD.
- 8' power cord with grounded plug.
- 115V AC.

Order No.	Mfg. No. / Description	Price
417422	(18610-0003) Pump	\$783.98 G
418524	(7273-0001-P) Impeller Neoprene, 6 Blades	\$36.98 G
418536	(7273-0003-P) Impeller Nitrile, 6 Blades	\$35.98 G

Jabco 6050 Series Flexible Impeller AC Motor Pump



- Largest.
- Continuous duty motor with thermal over-load protection.
- 23 GPM @ 10' head.
- Motor: 3/4 HP.
- Open drip proof motor.
- Will accept the optional Vacuum Switch (4732-0000) to automatically shut off the pump and prevent dry running.
- 1" NPT internal thread.
- 8' power cord with grounded plug.
- Motor wired to operate with 115V AC and can be converted to 230V AC.
- 115/230V AC.

Order No.	Mfg. No. / Description	Price
417507	(6050-0003) Pump	\$901.98 F
418412	(6056-0003-P) Impeller Nitrile, 8 Blades	\$152.98 G

Rule General Purpose Pump



- It is designed for use as a washdown pump and/or to circulate water to your livewell tank.
- Heavy duty construction for use on commercial or pleasure boats.
- 1-1/2" inlet and 1-1/2" discharge outlet.
- Must be mounted below the waterline.
- It does not deliver high pressure, nor is it self-priming.
- 3,800 GPH.
- 12 volt.

Order No.	Mfg. No. / Description	Price
582611	(17A)	\$278.98 F

- Fun & Flotation
- Anchor & Dock
- Safety
- Electronics
- Trolling Motors
- Lighting
- Electrical
- Topside Acc.
- Cockpit & Deck
- Instruments
- Steering, Controls
- Perform.
- Fuel System
- Engine & Parts
- Engine Care
- Propellers
- Seating & Pedestals
- Tops & Covers
- Pumps
- Cleaning & Care
- Paint & Paint Acc.
- Hardware, Fasteners
- Trailering
- Misc.
- Comm.

Johnson Pump Multi-Purpose Utility Pump

Johnson Pump



- Perfect for bilge pumping, deckwash, water circulation, oil and diesel refueling at dockside service, etc.
- 5.5 GPM.
- Can be combined with a vacuum switch for automatic operation.
- Connection 3/8" NPT.
- 12 volt.

Order No.	Mfg. No. / Description	Price
461961	(10-24516-03) F3B-19	\$224.98 Q

Johnson Pump Multi-Purpose Utility Pump

Johnson Pump



- Perfect for bilge pumping, deckwash, water circulation, oil and diesel refueling at dockside service, etc.
- 9 GPM.
- Can be combined with a vacuum switch for automatic operation.
- Connection 1/2" NPT and hose 1".
- 12 volt.
- Direct replacement for the Water Puppy.

Order No.	Mfg. No. / Description	Price
461962	(10-24727-03) F38B-19	\$230.98 Q
462286	(09-824P-9) Impeller	\$38.98 G

Johnson Pump DC Driven Flexible Impeller Pump

Johnson Pump



- Fully equipped, self-priming multipurpose pump operating on a simple and uncomplicated principle.
- Ideal for pumping water, oils and chemicals.
- 4 GPM.
- Can be combined with a vacuum switch for automatic operation.
- Connection 1/2" hose.
- 12 volt.

Order No.	Mfg. No. / Description	Price
461960	(10-24180-1) F2P10-19	\$335.98 Q
462328	(09-1077B-9) Impeller	\$40.98 G

Johnson Pump CM Series Magnetic Drive Circulating Pump

Johnson Pump



- Compact magnetic driven centrifugal pump which combines high flow rates with very low electric current consumption.
- Suitable for fresh water, ethylene glycol and salt water circulation.
- Hose connection 5/8" hose.
- 5.2 GPM at 3.3'.
- Liquid temperature from Minimum -40° C to Maximum +100° C.
- 12 volt.

Order No.	Mfg. No. / Description	Price
461970	(10-24503-03) CM30	\$287.98 Q

Rule Slimline In-Line Submersible Pump

rule



- Container filling and emptying.
- Bilge or storm water emptying.
- Suitable for diesel, fresh and salt water.
- Quick diesel transfer with no spillage.
- Water transfer, deck shower or deck wash.
- Continuous rating but should not be run dry for long periods.
- Includes: Spray nozzle, 13' cable with battery clips and 13' layflat hose.
- Fully submersible heavy duty construction.
- Outlets: 3/4" ID hose. Pump length 6.5", diameter: 1.5".
- 500 GPH.
- 12 volt.

Order No.	Mfg. No. / Description	Price
581707	(IL500PK)	\$111.98 Q

Marpac Washdown Pump - 3.5 GPM

marpac



- Delivers 3.5 GPM with a maximum pressure of 40 psi.
- Self-priming to 7' 10" (2.4m).
- For fresh or salt water use.
- Automatic high performance pump for deck and anchor washdown.
- Ideal for cleaning pleasure boats, fish boxes, scaling stations, anchor chains and dinghies.
- May also be used for full flow bait tank circulation.
- Automatic pump shut-off feature when hose nozzle is in off position.
- Includes plug-in ports for easy installation: (2) 3/4" hose barb ports and (2) garden hose ports.

Order No.	Description	Price
7-0900	Washdown Pump	\$155.98 G

Marpac Washdown Pump - 5.2 GPM

marpac



- Hi capacity, delivers 5.2 GPM at 70 psi for superior performance.
- Self-priming.
- Quiet, efficient, pulsation free and compact.
- Five chamber diaphragm pump that provides superior pressure.
- Strainer uses port connection for simple installation on inlet. (This makes it possible to remove entire unit for a thorough cleaning whenever it is most convenient). Strainer features a transparent cover for simple inspection.
- Easy push-in connections include 3/4" hose barbs and garden hose adapter.
- 12 volt. 3 year warranty. CE certified. Made in USA.

Order No.	Description	Price
7-0440	Washdown Pump	\$223.98 G

Marpac Washdown and Baitwell System

marpac



- Includes:
 - (1) 7-0900 - Washdown Pump
 - (1) 581858 - Rule 800 Pump
 - (1) 7-0423 - Coiled Washdown Hose with Nozzle

Order No.	Description	Price
7-0434	System	\$283.98 G

Fun & Flotation

Anchor & Dock

Safety

Electronics

Trolling Motors

Lighting

Electrical

Topside Acc.

Cockpit & Deck

Instruments

Steering, Controls

Perform.

Fuel System

Engine & Parts

Engine Care

Propellers

Seating & Pedestals

Tops & Covers

Pumps

Cleaning & Care

Paint & Paint Acc.

Hardware, Fasteners

Trailering

Misc.

Comm.

Jabsco PAR-Max 4.0 GPM Washdown Pump



- Flow rate to 4.0 GPM.
- Self-priming up to 10'.
- Shut off pressure 60 psi (4.3 bar).
- Suitable for high pressure applications.
- New compact 3 chamber design for greater pumping efficiency.
- Connections for 3/4" ID hose.
- Motor: Permanent magnet.
- ISO 8846 MARINE (ignition protection).
- 12 volt.

Fun & Flotation	Order No.	Mfg. No. / Description	Price
	414628	(32605-0092)	\$166.98 Q

WASHDOWN PUMP KIT

- Kit includes: Pumpgard intake strainer, pressure nozzle, port fittings and 25' of hose coil.

Anchor & Dock	Order No.	Mfg. No. / Description	Price
	414780	(32900-0092)	\$190.98 Q

Johnson Pump Aqua Jet 3.5 GPM Washdown Kit



- Kit includes:
 - Aqua Jet 3.5 GPM Washdown Pump, 5 bar (70 psi)
 - PUMProtector inlet strainer
 - Spray nozzle
 - Bulk head fitting with valve
 - 25' of high quality coiled hose
 - Illuminated panel switch
- 12 volt

Lighting	Order No.	Mfg. No. / Description	Price
	470750	(64535)	\$236.98 Q

Johnson Pump Aqua Jet Washdown Pumps



- As a washdown pump, the Aqua Jet offers much higher pressures than competitive models, making clean-up faster and easier than ever before.
- Complete with trigger nozzle, PUMProtector inlet strainer and hose connections for 1/2" hose.
- 1/2" NPT x 3/4" barb, 3/8" BSP x 1/2" barb.
- 3.5 GPM and 5.2 GPM Models includes GHT 3/4" connection.
- Made in the USA.

Electrical	Order No.	Mfg. No. / Description	Price
	470453	(10-24728-03) 2.9 GPM 2.8 bar - 41 psi 12 volt	\$147.98 R
	461830	(10-13399-03) 3.5 GPM 5 bar - 70 psi 12 volt	\$171.98 Q
	461835	(10-13407-07) 5.2 GPM 5 bar - 70 psi 12 volt	\$231.98 Q

Johnson Pump Aqua Jet Flow Master 5.0 Water Pressure System



- The ideal choice for pressurizing water in a closed system.
- The digital controller adjusts water flow as the demand is increased and decreased while maintaining a very smooth flow. The unique variable flow feature of the Flow Master pump allows the pump to be mounted without an accumulator tank and still maintain an even flow regardless if one or multiple taps are being used.
- 5 GPM. Pressure cut off: 3.5 bar, 50 psi.
- 12 volt.

Topside Acc.	Order No.	Mfg. No. / Description	Price
	470182	(10-13329-103)	\$288.98 G

Jabsco HotShot Series Washdown Pumps



- Sealed switch and co-moulded diaphragm, eliminates leak paths, extending the life of the pumps by up to 50%.
- Ergonomically designed spray nozzle provides powerful and accurate fire power with every shot.
- Quick Disconnect Ports allow for adjustable and ease of installation.
- Kits include: Pumpgard intake strainer, pressure nozzle and port fittings.
- Improved noise Dampening Rubber Feet, significantly minimizes vibration when mounted against hard surfaces.
- Sealed motor.
- Certified to En ISO 8846 Marine (Ignition Protection).
- Ports: 3/4" hose.
- 12 volt.

Order No.	Mfg. No. / Description	Price
414629	(82505-0092) 5.0 GPM	\$236.98 Q
414630	(82605-0092) 6.0 GPM	\$249.98 Q

Johnson Pump Aqua Jet 5.2 GPM Washdown Kit



- Kit includes:
 - Aqua Jet 5.2 GPM Washdown Pump, 5 bar (70 psi)
 - PUMProtector inlet strainer
 - Spray nozzle
 - Bulk head fitting with valve
 - 25' of high quality coiled hose
 - Illuminated panel switch
- 12 volt

Order No.	Mfg. No. / Description	Price
470749	(64534)	\$277.98 Q
470732	(64534CL) Clam Shell	\$257.98 Q

Johnson Pump Aqua Jet Washdown and Livewell Kit



- Kit includes:
 - Aqua Jet 5.2 GPM Washdown Pump, 5 bar (70 psi)
 - 500 GPH Twin Port Livewell Pump
 - PUMProtector inlet strainer
 - Spray nozzle
 - Bulk head fitting with valve
 - 25' of high quality coiled hose
 - Two illuminated panel switches
- 12 volt

Order No.	Mfg. No. / Description	Price
470751	(64634)	\$333.98 G

Shurflo Blaster™ Washdown Pump - 3.5 GPM

- Self-priming.
- Sealed switch.
- Quiet performance motor.
- Run dry capability.
- Seamless shell motor-waterproof.
- Ignition protected.
- Thermally protected.
- Shut-off pressure: 45 PSI.
- Includes: Blaster nozzle and fittings.
- 3.5 GPM
- 12 volt.

Order No. Mfg. No. / Description Price
353118 (4238-121-E07) **\$165.98** G

Shurflo Pro Blaster™ II Washdown Pump - 4.0 GPM

- Self-priming up to 6'.
- Sealed switch.
- Sealed motor.
- Corrosion resistant electro.
- Coated motor.
- Dry run capability.
- Built-in check valve.
- Ignition protected. Thermally protected.
- Shut-off pressure: 60 PSI.
- 4.0 GPM
- 12 volt.

Order No. Mfg. No. / Description Price
353160 (4248-153-E09) **\$212.98** G

Shurflo Pro Blaster™ II Washdown Pump Ultimate - 5.0 GPM

- Self-priming up to 6'.
- Sealed switch.
- Sealed motor.
- Corrosion resistant electro.
- Dry run capability.
- Built-in check valve.
- Ignition protected. Thermally protected.
- Shut-off pressure: 60 PSI.
- 5.0 GPM
- 12 volt.

Order No. Mfg. No. / Description Price
353150 (4258-153-E09) **\$298.98** G

Shurflo Pro Washdown Kit II Deluxe - 4.0 GPM

- Kit includes: Pro Blaster Pump, 25' coiled hose, nozzle, raw water strainer and fittings.
- Run dry capability.
- Self-priming up to 6'.
- SHURcote II seamless motor.
- Sealed switch.
- Ignition protected. Thermally protected.
- Shut-off pressure: 60 PSI.
- 4.0 GPM.
- 12 volt.

Order No. Mfg. No. / Description Price
353172 (4348-153-E09) **\$267.98** G

Flojet General Purpose Pump - Quad II**FLOJET**

- 3.3 GPM for 15-30 gallon tanks.
- Four chamber diaphragm positive displacement design.
- Self-priming up to 6 ft. suction lift.
- Pump able to run dry without damage.
- Soft, noise absorbing mounts.
- Corrosion resistant materials.
- Meet USCG Electric Standards.
- Removable port to hose connectors and strainer included.

Order No. Mfg. No. / Description Price
352574 (04105501A) **\$197.98** Q

Johnson Pump Flush Mount Deckwash 316 Stainless Fitting

- Flush mount.
- Connects and disconnects under full pressure.
- Positive lock bayonet connector.
- Double viton o-ring seals.
- Large flow capacity.
- 316 stainless steel.
- Connections made of nylon 66.

Order No. Mfg. No. / Description Price
470072 (61121) Single Outlet Single Flush **\$97.98** G
470074 (61122) Double Outlet 2 Way Flush **\$103.98** Q

Flojet Heavy Duty Deck Wash Pumps**FLOJET**

- 4.5 GPM, 40 psi shutoff.
- Four chamber positive displacement diaphragm design.
- Includes strainer.
- Self-priming up to 10 ft. suction lift.
- Pump able to run dry without damage.
- Soft, noise absorbing mounts.
- Corrosion resistant materials.
- Removable port to hose connectors.
- Models Meet USCG Electric Standards.
- Thermally protected.
- Motor: Permanent magnet, ball bearings at front and rear end bell.

Order No. Mfg. No. / Description Price
352714 (04325143L) 12 volt **\$250.98** G
352575 (04325043A) 115V AC **\$326.98** Q
352500 (02090118) Pressure Switch Assembly **\$47.98** G

Fun & Flotation

Anchor & Dock

Safety

Electronics

Trolling Motors

Lighting

Electrical

Topside Acc.

Cockpit & Deck

Instruments

Steering, Controls

Perform.

Fuel System

Engine & Parts

Engine Care

Propellers

Seating & Pedestals

Tops & Covers

Pumps

Cleaning & Care

Paint & Paint Acc.

Hardware, Fasteners

Trailering

Misc.

Comm.

Gilmour Nylon Hose Repair Accessories

Gilmour

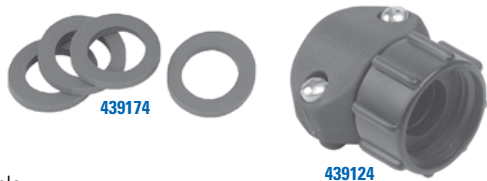

- Leakproof, reusable.
- For rubber or plastic hose.
- Fits 5/8" or 3/4" hose.
- Nylon construction for maximum strength and durability.
- Patented impact resistant clamp design.
- Non-corroding high grade stainless steel screws will not strip when tightened.

Order No.	Mfg. No. / Description	Price
439124	(01F) Female Coupling	\$5.00 LQ
439174	(01RW) Neoprene Hose Washers (10 Per Package)	\$3.96 LQ

Gilmour Reinforced Vinyl Garden Hose

Gilmour



- 4-ply construction.
- Weather, abrasion and kink resistant.
- Good burst strength; withstands nozzle shut-off.
- Full-Flo brass couplings for unrestricted water flow.

Order No.	Mfg. No. / Description	Price
646109	(15-58050) 5/8" x 50'	\$34.98 LQ

Camco TastePURE Premium Drinking Water Hoses

CAMCO



- Heavy duty reinforced 5/8" ID drinking water hoses are 20% thicker than our standard hoses.
- Rated for 300 PSI and NSF listed.
- BPA free, phthalate-free formulation.
- Anti-kink design features machined fittings and spring reinforced ends for added durability at connection points.
- Drinking water safe.
- UV-stabilized for long life.
- Made in the USA.

Order No.	Mfg. No. / Description	Price
689040	(22833) Length 25'	\$22.98 F
689042	(22853) Length 50'	\$34.98 F

Groco Salt Water Pistol-Grip Nozzle

GROCO



- Squeeze for fine spray to stream, release it for instant shut off.
- Locks in position.
- Designed and built specifically for continuous use with saltwater.
- All parts are corrosion-free plastic, except for the internal stainless steel return spring.

Order No.	Mfg. No. / Description	Price
371118	(PGN-50)	\$14.98 F

Marpac Coiled Washdown Hoses with Nozzle



- Corrosion resistant construction with stainless steel spring and solid brass fittings.
- No-kink design. Drinking water safe.
- Quick connect fitting with shut off.
- Removable quick connect adaptor.
- 35% more flow at 40 PSI.

Order No.	Description	Price
7-0422	1/2" x 15' Coiled Washdown Hose with Nozzle	\$29.98 F
7-0423	1/2" x 25' Coiled Washdown Hose with Nozzle	\$32.98 F
7-0425	Hose Nozzle with Quick Fitting	\$4.98 G

MPI Products Marine Washdown Hose



- Flexible reinforced PVC that is drinking-water safe.
- White with blue stripe.
- Vinyl-protected, non-corrosive couplings will not mar decks and other surfaces.
- 5/8" ID.

Order No.	Mfg. No. / Description	Price
771630	(22783) Length 25'	\$27.98 G
771700	(22793) Length 50'	\$47.98 G

Marpac Hose Nozzle



- Corrosion resistant.
- Quick connect fitting with shut off.

Order No.	Description	Price
7-0425	Hose Nozzle	\$4.98 G

Spray Nozzle



- Zinc Alloy spray nozzle with insulated handle.
- Soft grip and front thread protector.
- 5-1/2".

Order No.	Mfg. No. / Description	Price
485638	(30-600)	\$17.98 F

Marpac Water Inlet and Outlet - Stainless Steel



- 316 cast stainless steel.
- 2-3/4" OD.
- For use with 1/2" hose.

Order No.	Description	Price
7-0418	Water Inlet	\$37.98 G
7-0419	Water Outlet	\$33.98 G

T-H Marine Washdown Fittings



- Injection molded - rust proof.
- Plastic cap with retainer.
- Standard garden hose threads.
- Fits 3/4" hose.
- Flange is 2-1/4" diameter and fits 1-1/4" hole.

Order No.	Mfg. No. / Description	Color	Price
641360	(WDV-1-DP) With Shut-Off Valve	Black	\$29.98 H
641301	(WDV-1CP-DP) With Shut-Off Valve	Chrome	\$30.98 H
772272	(WD-1CP-DP) Without Shut-Off Valve	Chrome	\$28.98 H

Jabco Water Pressure Regulators



- Reduces unregulated city water pressures that can run as high as 125 psi down to a safe 45 psi - automatically.
- Maintains regulated pressure at various flow rates.
- Removable strainer protects plumbing.
- Meets all applicable codes and approvals.
- Flush model: Regulator outlet accepts snap-fit port fittings. Connections for 3/4" GHT (f) inlet and 1/2" - 14 pipe outlet.
- In-line model: Connections 3/4" GHT (f) inlet and 3/4" GHT (m) outlet.

Order No.	Mfg. No. / Description	Price
414704	(44412-1045) Flush Model	\$44.98 G
414716	(44411-0045) In-line Model	\$40.98 Q

Perko Water Deck Fill



- Chrome plated cast bronze.
- 1-1/2" IPT.
- Flange OD 3-5/8".
- Deck plate key and O-ring included.
- Have a slot between the holes.

Order No.	Mfg. No. / Description	Price
540458	(0528 DPW CHR)	\$143.98 R

Perko Fig. 499 Water Inlet Fitting



- Chrome plated bronze.
- Standard female swivel hose connector.
- Black polymer watertight plug and stainless steel bead chain.
- For obtaining water under pressure at dockside.
- Flange OD 2-3/4". Pipe size 1/2".
- Uses #8 fasteners.

Order No.	Mfg. No. / Description	Price
539429	(0499 DPO CHR)	\$112.98 R

Perko Fig. 504 Water Outlet Fitting



- Chrome plated bronze.
- Standard male hose connector.
- Black polymer watertight cap and stainless steel bead chain.
- For use with on-board washdown systems.
- Flange OD 2-3/4". Pipe size 1/2".
- Uses #8 fasteners.

Order No.	Mfg. No. / Description	Price
539444	(0504 DPO CHR)	\$82.98 R

Johnson Pump Water Pressure Regulator



Order No.	Mfg. No. / Description	Price
470130	(40057)	\$33.98 G

Jabco High Pressure Check Valve



- When located at the pump outlet, these high pressure check valves protect your pump from the damaging high pressure of unregulated marina service connections.
- Also can be located at the water heater inlet to prevent backflow of hot water into cold water system and pump.
- For 1/2" slip-on hose inlet and outlet.

Order No.	Mfg. No. / Description	Price
414689	(34344-0000)	\$66.98 E

- Fun & Flotation
- Anchor & Dock
- Safety
- Electronics
- Trolling Motors
- Lighting
- Electrical
- Topside Acc.
- Cockpit & Deck
- Instruments
- Steering, Controls
- Perform.
- Fuel System
- Engine & Parts
- Engine Care
- Propellers
- Seating & Pedestals
- Tops & Covers
- Pumps
- Cleaning & Care
- Paint & Paint Acc.
- Hardware, Fasteners
- Trailering
- Misc.
- Comm.

- Fun & Flotation
- Anchor & Dock
- Safety
- Electronics
- Trolling Motors
- Lighting
- Electrical
- Topside Acc.
- Cockpit & Deck
- Instruments
- Steering, Controls
- Perform.
- Fuel System
- Engine & Parts
- Engine Care
- Propellers
- Seating & Pedestals
- Tops & Covers
- Pumps
- Cleaning & Care
- Paint & Paint Acc.
- Hardware, Fasteners
- Trailer
- Misc.
- Comm.

Jabco Multi-Outlet Electric Fresh Water System Pump



- Diaphragm design allows dry running.
- Self-priming up to 4.9' vertical lift.
- Built-in discharge check valve.
- Quiet operation.
- Built-in hydraulic pulsation dampener.
- Large vibration absorbing pads.
- Port type: 1/2" or 5/8" ID hose barb.
- Shut-off pressure 40 PSI (2.7 bar).
- 12 volt.



Order No.	Mfg. No. / Description	Price
414499	(36950-2000) 3 GPM	\$430.98 E
425721	(37121-0010) Pressure Switch	\$49.98 F

Jabco Multi-Outlet Electric Fresh Water System Pump



- Diaphragm design allows dry running.
- Self-priming up to 4.9' vertical lift.
- Built-in discharge check valve.
- Quiet operation.
- Built-in hydraulic pulsation dampener.
- Large vibration absorbing pads.
- Port type: 1/2" or 5/8" ID hose barb.
- Shut-off pressure 40 PSI (2.7 bar).
- 12 volt.



Order No.	Mfg. No. / Description	Price
414526	(36800-1000) 3.3 GPM	\$550.98 E
425721	(37121-0010) Pressure Switch	\$49.98 F

Jabco PAR-Max 1.9 GPM Water Pressure System Pump



- Smooth flow.
- Dry running capability.
- Soft noise absorbing mounts.
- Snap-fit port fittings.
- Built-in bypass-less pulsation.
- Reduces need for accumulator tank.
- Self-priming from dry up to 2.4 m (7.8 ft).
- Port type: 1/2" hose barb.
- Shut-off pressure 25 PSI (1.7 bar).
- 12 volt.



Order No.	Mfg. No. / Description	Price
418084	(31295-0092) 1.9 GPM	\$115.98 G

Jabco PAR-Max 2.9 GPM Water Pressure System Pumps



- Smooth flow.
- Dry running capability.
- Soft noise absorbing mounts.
- Snap-fit port fittings.
- Built-in bypass-less pulsation.
- Reduces need for accumulator tank.
- Self-priming from dry up to 2.4 m (7.8 ft).
- Port type: 1/2" hose barb.
- Shut-off pressure 50 PSI (3.4 bar).
- 2.9 GPM.



Order No.	Mfg. No. / Description	Price
414603	(31395-0092) 12 volt	\$125.98 G
414480	(31395-0094) 24 volt	\$135.98 Q

Jabco PAR-Max 3.5 GPM Water Pressure System Pump



- Smooth flow.
- Dry running capability.
- Soft noise absorbing mounts.
- Snap-fit port fittings.
- Corrosion resistant materials.
- Self-priming from dry up to 3 m (10 ft).
- Shut-off pressure 40 PSI (2.8 bar).
- 12 volt.



Order No.	Mfg. No. / Description	Price
414487	(32600-0092) 3.5 GPM	\$170.98 Q

Jabco PAR-Max 4 GPM Water Pressure System Pump



- Smooth flow.
- Dry running capability.
- Soft noise absorbing mounts.
- Snap-fit port fittings.
- Corrosion resistant materials.
- Self-priming from dry up to 2.4 m (7.8 ft).
- Shut-off pressure 40 PSI (2.8 bar).
- Port type: 1/2" hose barb or thread.
- 12 volt.



Order No.	Mfg. No. / Description	Price
414490	(31620-0092) 4.3 GPM	\$223.98 G

Jabco PAR-Max Plus Water Pressure System Pumps



- Automatic pressure switch.
- Dry running capability.
- Improved noise dampening rubber feet.
- Quick disconnect ports allow for ease of installation.
- Self-priming from dry up to 3 m (10 ft).
- Corrosion resistant materials.
- Shut-off pressure 60 PSI (4.1 bar).
- 12 volt.



Order No.	Mfg. No. / Description	Price
418080	(82500-0092) 5.0 GPM	\$225.98 G
418082	(82600-0092) 6.0 GPM	\$236.98 G

Jabco V-FLO Water Pressure Pump - 5.0 GPM



- Feature the revolutionary new DiMOND technology designed to automatically diagnose and monitor all aspects of your pump's performance to prevent system failure.
- Dry running capability.
- Self-priming from dry up to 3 m (10 ft).
- Port type: 1/2" hose barb or thread.
- Shut-off pressure 60 PSI (4.1 bar).
- 12 volt.



Order No.	Mfg. No. / Description	Price
414701	(42755-0092) 5.0 GPM	\$377.98 G

Items are stocked in our warehouses based on regional demand. If an item is out of stock in your local warehouse, additional charges may apply.

Marpac Water Pressure System Pump - 5.2 GPM



- Hi capacity pump delivers 5.2 GPM for superior performance.
- Self-priming.
- Five chamber diaphragm pump that provides 41 psi.
- Quiet, efficient, pulsation free and compact.
- Easy 1/2" push-in hose barb connections included make rigging simple.
- 12 volt.
- 3 year warranty.
- CE certified.
- Made in USA.

Order No.	Description	Price
7-0441	Water Pressure System - 5.2 GPM	\$236.98 G

Johnson Pump Aqua Jet Flow Meter Variable Speed WPS - 5.0 GPM



- Ideal choice for pressurizing water in a closed system.
- The digital controller adjusts water flow as the demand is increased and decreased while maintaining a very smooth flow.
- The unique variable flow feature of the Flow Master pump allows the pump to be mounted w/o an accumulator tank and still maintain an even flow regardless if one or multiple taps are being used.
- Pressure cut off: 50 PSI (3.5 bar).
- 5.0 GPM. 12 volt.
- Made in the USA.

Order No.	Mfg. No. / Description	Price
461950	(10-13329-103)	\$288.98 G

Shurflo Aqua King™ II Premium Water Pump - 4.0 GPM

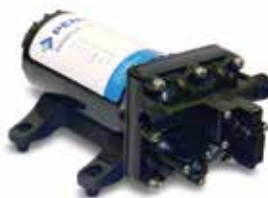

- A built in mechanical bypass function enables these pumps to vary the flow rate for any on demand condition, without the need for an accumulator.
- Self priming up to 6' and run dry capability.
- Ignition and thermally protected.
- Provides "just like home" shower pressure to multiple fixtures.
- Equipped with a seamless motor shell, Shur-coated for corrosion protection, waterproof pressure switch.
- Fittings included: 1/2" straight wing nut swivel barb, 1/2" elbow wing nut swivel barb.
- Shut off pressure: 55 PSI (3.8 bar).
- 4.0 GPM. 12 volt.
- 3 year warranty. CE Listed.

Order No.	Mfg. No. / Description	Price
353122	(4148-153-E75)	\$230.98 G

Shurflo Aqua King™ Standard Water Pump - 3.0 GPM

- Self-priming.
- Sealed switch.
- Quiet performance.
- Run dry capability.
- Seamless shell E-coated motor.
- Multi-fixture.
- Ignition and thermally protected.
- Shut off pressure: 55 PSI (3.8 bar).
- 3.0 GPM.
- 12 volt.
- 3 year warranty.
- CE Listed.

Order No.	Mfg. No. / Description	Price
353100	(4138-111-E65)	\$138.98 G

Johnson Aqua Jet Water Pressure System Pumps



- The five chamber Aqua Jet WPS provides a reliable heart for small boat and recreational vehicle water pressure system.
- Whisper quiet operation. Self-priming.
- Pressure switch standard.
- Pressure cut off: 41 PSI (2.8 bar).
- May be used with optional accumulator tank.
- Optional inlet strainer 09-24653-02-CN clicks into pump.

Order No.	Mfg. No. / Description	Price
470043	(10-13405-103) 2.9 GPM 12 volt	\$124.98 Q
461954	(10-13395-103) 3.5 GPM 12 volt	\$155.98 Q
461955	(10-24677-03) 3.5 GPM 12 volt Includes Inlet Strainer	\$168.98 Q
461956	(10-13406-103) 4.0 GPM 12 volt	\$171.98 Q
461958	(10-13406-107) 5.2 GPM 12 volt	\$224.98 Q

Flojet Quad DC Water System Pumps - 3.3 GPM



- Self-priming up to 2.4m vertical lift.
- Four-piston design delivers higher flow rates.
- Quick-connect plug-in ports for easy installation.
- Pressure-switch control to run the pump only as needed.
- Includes plug-in ports for easy installation: (2) 1/2" Qest ports and (2) 1/2" hose barb ports.
- Shut off at 35 PSI (2.5 bar).
- 3.3 GPM.

Order No.	Mfg. No. / Description	Price
352702	(04405143A) 12 volt	\$156.98 G
352738	(04405443A) 32 volt	\$197.98 Q
352524	(02090104) Pressure Switch	\$47.98 G

Shurflo Aqua King™ II Supreme Water Pump - 5.0 GPM



- A built in mechanical bypass function enables these pumps to vary the flow rate for any on demand condition, without the need for an accumulator.
- Self priming up to 6' and run dry capability.
- Ignition and thermally protected.
- Provides "just like home" shower pressure to multiple fixtures.
- Equipped with a seamless motor shell, Shur-coated for corrosion protection, waterproof pressure switch.
- Fittings included: 1/2" straight wing nut swivel barb, 1/2" elbow wing nut swivel barb.
- Shut off pressure: 55 PSI (3.8 bar).
- 5.0 GPM. 12 volt.
- 3 year warranty. CE Listed.

Order No.	Mfg. No. / Description	Price
353146	(4158-153-E75)	\$314.98 G

- Fun & Flotation
- Anchor & Dock
- Safety
- Electronics
- Trolling Motors
- Lighting
- Electrical
- Topside Acc.
- Cockpit & Deck
- Instruments
- Steering, Controls
- Perform.
- Fuel System
- Engine & Parts
- Engine Care
- Propellers
- Seating & Pedestals
- Tops & Covers
- Pumps**
- Cleaning & Care
- Paint & Paint Acc.
- Hardware, Fasteners
- Trailering
- Misc.
- Comm.

Johnson Pump Aqua Jet UNO WPS Assembly - 5.2 GPM

Johnson Pump

- Medium capacity unit with a single Aqua Jet WPS fixed on a base with PUMP Protector inlet strainer and a 2 liters pre-pressurized accumulator tank.
- Pressure cut off: 41 PSI (2.8 bar).
- 5.2 GPM.
- Fuse size 15A.
- Connection: 3/4" hose.
- 12 volt.
- Made in the USA.



Order No. Mfg. No. / Description Price
461953 (10-13408-03) 5.2 GPM **\$630.98** Q

Johnson Pump Aqua Jet Duo WPS - 10.4 GPM

Johnson Pump

- High capacity unit with two parallel connected Aqua Jet WPS capacity 10.4 GPM fixed on a base with PUMP Protector inlet strainers and a 2 liters pre-pressurized accumulator tank.
- Pressure cut off: 41 PSI (2.8 bar).
- 10.4 GPM.
- Fuse size 25A.
- Connection: 3/4" hose.
- 12 volt.
- Made in the USA.



Order No. Mfg. No. / Description Price
461840 (10-13409-01) 10.4 GPM **\$1,025.98** Q

Flojet High Volume Water Pressure System - 4.5 GPM

FLOJET

- Integrated pump and accumulator tank system.
- Designed to provide steady water pressure and generous water flow.
- The pump is fully automatic with a built-in switch and check valve to maintain system pressure and will supply smooth water flow from a trickle to full flow.
- May be mounted vertically or horizontally.
- Self-priming up to 10'. Can run dry without harm.
- Accumulator tank has total volume of 1.1 Gallon.
- Includes: Strainer and assorted ports for easy installation.
- Pressure shut off: 40 PSI (2.8 bar).
- 12 volt.



Order No. Mfg. No. / Description Price
352726 (02840100A) 4.5 GPM **\$599.98** Q

Jabco PAR-Max 4.0 GPM Bilge and Shower Drain Pump

JABSCO

- New generation, continuous rated bilge pump with waterproof coating for harsh environments.
- Built-in thermal overload protection.
- Run dry without damage.
- Snap-in ports.
- Self-priming up to 10' allows mounting above wet bilges.
- 258 GPH open flow output.
- Connections for 3/4" ID hose.
- Complete with Pumpgard strainer.
- 12 volt.



Order No. Mfg. No. / Description Price
414817 (31705-0092) 258 GPH **\$224.98** F

Rule Shower Drain System - 800 GPH

rule

- A compact, full capacity shower drain system.
- Automatically turns on after the water starts and shuts off when the water is removed.
- Activated by a non-mercury Rule-A-Matic Plus float switch.
- A clear screw down cover, removable strainer for easy cleaning and an internal check valve to prevent back flow.
- Discharge 3/4".
- Dimensions: 8-1/4" x 11-1/4" x 5-1/2".
- Includes three inlet ports which offer varying combinations of inlet hose.



Order No. Mfg. No. / Description Price
581719 (98A) 800 GPH **\$145.98** E

Johnson Pump Multiple Port Shower Sump with Ultima Switch

Johnson Pump

- Designed to work flawlessly in harsh environments, ultima switch is mercury free, has no moving parts, ignores dirt, grease, hair, detergents, and other nasty contaminants that enter the typical shower sump.
- Multiple port shower sump with ultima switch.
- Dimensions: 8.26" W x 11.42" L.
- Capacity 1.0 m head: 844 GPH. Capacity straight: 972 GPH.
- 12 volt.



Order No. Mfg. No. / Description Price
470067 (57151) **\$141.98** Q
470070 (54304) Clear Sump Cover **\$8.98** G

Kuuma Products Water Heater

KUUMA

- Marine quality aluminum alloy case with TIG welded tanks.
- Front heat exchange, front/back mount.
- Two different mounting bracket options on each heater.
- Large diameter dual loop heat exchanger is standard.
- High temp limiter with automatic reset after breaker cycle.
- Water heaters of choice for Sea Ray, Cruisers Yachts, Four Winns, Hunter, Crownline, Beneteau and Boston Whaler.
- All water heaters are ETL listed to UL 174.



Order No. Mfg. No. / Description Price
609101 (11811) 6 Gallon 120 volt **\$383.98** R
609202 (11841) 11 Gallon 120 volt **\$455.98** Q

- Fun & Flotation
- Anchor & Dock
- Safety
- Electronics
- Trolling Motors
- Lighting
- Electrical
- Topside Acc.
- Cockpit & Deck
- Instruments
- Steering, Controls
- Perform.
- Fuel System
- Engine & Parts
- Engine Care
- Propellers
- Seating & Pedestals
- Tops & Covers
- Pumps
- Cleaning & Care
- Paint & Paint Acc.
- Hardware, Fasteners
- Trailer
- Misc.
- Comm.

Franklin Water Pressure Systems

- For installations where the vertical distance from the pump to the pumping water level does not exceed 25 feet.
- Cast iron casting and seal plate for durability and long life.
- Pressure switch preset at 30-50 PSI.
- 1-1/4" NPT suction and 1" NPT discharge.
- Pressure gauge included.
- Stainless steel motor shaft and dual ball bearings.
- Precision-engineered thermoplastic impeller, diffuser, nozzle and venturi.
- Clean-out plug to easily unclog nozzle.
- 115/230 volts.



Order No.	Mfg. No. / Description	Price
496186	(558279) JPH-50-C High Pressure Pump Only 1/2 HP	\$426.98 Q
496201	(558275MJS75) JP-075-C Standard Pressure Pump Only 3/4 HP	\$602.98 Q
496194	(558276MJS100) JP-100-C Standard Pressure Pump Only 1 HP	\$564.98 Q
496188	(604050) Base Plate for Pump System	\$31.98 LQ
496190	(604457) RL20 Pressure Tank - 20 Gallon	\$289.98 Q
496191	(604459) RL44 Pressure Tank - 44 Gallon	\$583.98 Q
496302	(305446943) Seal Plate	\$37.98 LQ
496338	(224310) Pressure Switch	\$44.98 F

Model No.	Motor HP	Total Suction Lift (ft.)	Pump Capacity in U.S. GPM													Maximum Pressure (PSI)
			Discharge Pressure in PSI													
			20	25	30	35	40	45	50	55	60	65	70	75	80	
JP-075-C	3/4	5	16.2	16	15.8	15.6	15.4	12.1	8.7	5.7	2.9	-	-	-	-	65
JP-075-C	3/4	10	14.3	14	13.7	13.5	13.2	10.6	7.6	4.6	1.6	-	-	-	-	62.8
JP-075-C	3/4	15	12.1	11.7	11.3	11	10.6	9.3	6.3	3.2	0.2	-	-	-	-	60.6
JP-075-C	3/4	20	9.9	9.6	9.3	9	8.7	7.8	4.8	1.9	-	-	-	-	-	58.5
JP-075-C	3/4	25	7.2	7.1	7	6.9	6.8	6.7	3.5	0.6	-	-	-	-	-	56.3
JPH-50-C	1/2	5	8.8	8.9	8.6	8.4	8.3	8.1	7.4	6	4.7	-	-	-	-	80.6
JPH-50-C	1/2	10	7.8	7.7	7.55	7.4	7.25	7.2	6.6	5.4	4.15	-	-	-	-	78.5
JPH-50-C	1/2	15	6.5	6.4	6.3	6.2	6.1	6	5.3	4.8	3.6	-	-	-	-	76.3
JPH-50-C	1/2	20	5.3	5.2	5.1	4.9	4.8	4.7	4.6	4.1	2.9	-	-	-	-	74.1
JPH-50-C	1/2	25	3.7	3.65	3.6	3.55	3.5	3.5	3.45	2.4	2.3	-	-	-	-	71.9
JP-100-C	1	5	24.8	24.7	23.2	19.8	16.5	13.1	9.5	6.3	3.4	0.5	-	-	-	66.2
JP-100-C	1	10	21.5	21.2	20.1	18.4	15.2	11.5	7.9	4.9	2.4	-	-	-	-	64.2
JP-100-C	1	15	18.1	17.8	17.4	16.7	13.8	10.3	6.9	4	1.3	-	-	-	-	62.1
JP-100-C	1	20	14.4	14.3	14.2	14.6	12.3	9	5.3	2.3	0.2	-	-	-	-	60.1
JP-100-C	1	25	10.5	10.5	10.4	10.3	8.8	7	4.2	1.3	-	-	-	-	-	57.2

- Fun & Flotation
- Anchor & Dock
- Safety
- Electronics
- Trolling Motors
- Lighting
- Electrical
- Topside Acc.
- Cockpit & Deck
- Instruments
- Steering, Controls
- Perform.
- Fuel System
- Engine & Parts
- Engine Care
- Propellers
- Seating & Pedestals
- Tops & Covers
- Pumps
- Cleaning & Care
- Paint & Paint Acc.
- Hardware, Fasteners
- Trailering
- Misc.
- Comm.

Jabsco Pneumatic Accumulator Tank



- This pneumatic accumulator tank will smooth flow from faucets and shower, reducing pump cycling and eliminating pulsations and water hammer.
- Water is totally separated from air chamber by a diaphragm and polypropylene tank liner.
- Volume of tank is 2 gallons with a working water volume of about 1 gallon.
- Mounts horizontally or vertically, even upside down.
- Port is 3/4" NPT (male). Includes brackets and band clamps.
- May be fine tuned to cut-in pressure of pump.
- Diameter 8", height 12-5/8".
- Pre-pressurized to 20 PSI.
- Maximum working pressure 100 PSI.

Order No.	Mfg. No. / Description	Price
414641	(18810-0000)	\$214.98 E

Groco Pressure Storage Tanks



- A pneumatic pressure charge, matched to the pump cut-on pressure prevents waterlogging by separating the air charge from system water pressure with a rubber bladder.
- The result is smooth pressure delivery, even temperature mix in showers, and reduced pump cycling.
- Tanks may be mounted in any position and anywhere in the cold water plumbing after the pump.
- PST tanks may be used for fresh or salt water.
- Mount hardware is included.
- Pipe connection 3/4".
- * Drawdown is measured with 20 PSI air charge and with 40 PSI system water pressure.

Order No.	Mfg. No.	Capacity	Diameter	Length	Drawdown*	Price
375143	(PST-1)	1 Gallon	8"	12.63"	.5 Gallon	\$153.98 F
S/O	(PST-2)		11"	14"	1.4 Gallons	POR
375154	(PST-3A)	2.7 Gallon	15.4"	19.25"	3 Gallons	\$470.98 F
S/O	(PST-4)		15.4"	24"	4.4 Gallons	POR

FCI Watermakers Aquamiser+



Order No.	Framed	Modular	GPD/LPD	GPH/LPH	HP	KW	Voltage
S/O	A216S	AM216S	250/946	10/39	1.5	1.52	120/220, 50/60 Hz
343201	A516S	AM516S	500/1892	21/79	1.5	1.52	120/220, 50/60 Hz
S/O	A616S	AM616S	600/2270	25/95	1.5	1.52	120/220, 50/60 Hz
S/O	A816S	AM816S	800/3027	33/126	1.5	1.52	120/220, 50/60 Hz
S/O	A1226S	AM1226S	1200/4541	50/189	2.5	2.29	120/220, 50/60 Hz
S/O	A1826S	AM1826S	1800/6811	75/284	2.5	2.29	120/220, 50/60 Hz

Order No.	Mfg. No. / Description	Price
343235	(50-2576) Remote Display Panel	\$875.00 A

STANDARD FEATURES

- Staged starting of motors.
- Timed start-up (Prime, Init, Run).
- TDS monitoring of product water.
- Automatic diverting of water above 500 PPM.
- Programmable Fresh Water Flush for automatic and weekly operation; or, convenient one-touch button for manual operation.
- Overpressure protection (HP fault).
- Loss of Prime/Fouled Filter detection (LP fault).

The Aquamiser Plus Series offers programmable settings and remote display capability through an advanced control marine reverse osmosis system. This value-driven solution is ideal for smaller water production needs. With outputs of 250 to 1800 GPD, the Aquamiser Plus marine watermaker will provide the safety and controls needed to operate both dependably and efficiently. These marine reverse osmosis systems are available in framed and modular configurations to be utilized in tight spaces and bulkheads. Small only in size, the Aquamiser Plus marine R/O unit features extensive controls, including a fully automatic fresh water flush system for unattended maintenance. Scheduled weekly or biweekly flushes will help keep your marine water maker fresh and ready for your next voyage.



WITH REMOTE DISPLAY

- Remote system control up to 150' away.
- Readout of product TDS.
- Automatic tank level controls.
- Programmable times/set points and display settings.

FCI Watermakers Max-Q



STANDARD FEATURES

- State-of-the-art engineering and electronics, UROC-Universal R/O Controller with computer interface and multiple remote station capability.
- RS-485 connection for display and monitoring up to 4000 ft. away.
- 316SS low-pressure pump with closed impeller design.
- Programmable Fresh Water Flush with recurring automatic flush feature.
- Digitally monitors water pressure and flow.
- Quiet, efficient operation.
- Conservatively rated to insure performance under varying conditions.
- Commercial sized pre-filtration.
- 316SS high-pressure pump and fittings.
- Pressure vessels with 316SS product and pressure ports, stress-eliminating engineering with LIFETIME WARRANTY.
- Washdown duty motors (epoxy coated, neoprene gaskets).
- User-friendly with ergonomic design for ease of use.
- 4-point vibration isolation mounts for quiet operation.
- 2-year product warranty.



Order No.	Framed	Modular	GPD/LPD	GPH/LPH	HP	KW	Voltage
S/O	MQ726S	MQM726S	700/2649	29/110	2.5	2.29	120/220/380, 1-ph, 3-ph, 50/60 Hz
343204	MQ1226S	MQM1226S	1275/4825	53/201	2.5	2.29	120/220/380, 1-ph, 3-ph, 50/60 Hz
S/O	MQ1826S	MQM1826S	1850/7000	77/292	2.5	2.29	120/220/380, 1-ph, 3-ph, 50/60 Hz

Order No.	Mfg. No. / Description	Price
343232	(50-2185) Universal Reverse Osmosis Controller (UROC)	\$875.00 A

The Max-Q Series is among the most advanced marine watermaker ever manufactured. You can customize your watermaking needs with FCI's exclusive UROC technology - the industry's first remote monitoring and control system for watermakers. Monitor and run your marine reverse osmosis system from a remote location or a personal computer. Both framed and modular configurations produce fresh, clean water with outputs of 600, 1200 or 1800 GPD. Because each component is test and chosen for its ability to withstand long-term operation, every Max-Q marine water making system is engineered and designed to operate in the harshest of marine environments. Our units are so advanced we have eliminated the need for pressure gauges and flow meters, leaving you with worry-free operation and years of dependable service.

- Fun & Flotation
- Anchor & Dock
- Safety
- Electronics
- Trolling Motors
- Lighting
- Electrical
- Topside Acc.
- Cockpit & Deck
- Instruments
- Steering, Controls
- Perform.
- Fuel System
- Engine & Parts
- Engine Care
- Propellers
- Seating & Pedestals
- Tops & Covers
- Pumps
- Cleaning & Care
- Paint & Paint Acc.
- Hardware, Fasteners
- Trailing
- Misc.
- Comm.

FCI Watermakers Neptune



STANDARD FEATURES

- The Neptune Series is available in 3 convenient configurations State-of-the-art engineering.
- UROC - Universal Reverse Osmosis Controller with computer interface.
- 316SS low-pressure pump with closed impeller design (producing 50% more pressure with the same horsepower).
- 316SS high-pressure pump.
- Multiple station capabilities.
- Programmable Fresh Water Flush with recurring automatic flush feature.
- Commercially designed to operate 24/7, 365 days per year.
- Pressure vessels with 316SS pressure and product ports, stress-eliminating engineering.
- 80 sq. ft. of commercial pre-filtration.
- Conservatively rated to ensure performance under varying conditions.
- Built-in cleaning ports.
- Washdown duty motors (epoxy coated, neoprene gaskets).
- 4-point vibration isolation mounts.
- One year warranty.

Horizontal	GPD	M3	GPH/LPH	HP	KW	Voltage
NH12263S	1275	5	53/201	3	2.98	220/380/460, 3-ph, 50/60 Hz
NH18263S	1850	7	77/292	3	2.98	220/380/460, 3-ph, 50/60 Hz
NH25263S	2500	9	104/394	5	4.47	220/380/460, 3-ph, 50/60 Hz
NH31236S	3100	12	129/489	7.5	6.34	220/380/460, 3-ph, 50/60 Hz
NH43263S	4300	16	179/678	7.5	6.34	220/380/460, 3-ph, 50/60 Hz
NH55263S	5500	21	229/867	7.5	6.34	220/380/460, 3-ph, 50/60 Hz
NH75263S	7500	28	313/1183	10	8.20	220/380/460, 3-ph, 50/60 Hz
NH95263S	9500	36	396/1498	10	8.20	220/380/460, 3-ph, 50/60 Hz

Wall-Mount	Modular	GPD	M3	GPH/LPH	HP	KW	Voltage
-	NM12263S	1200	5	50/189	3	3.05	220/380, 3-ph, 50/60 Hz
-	NM18263S	1800	7	75/284	3	3.05	220/380, 3-ph, 50/60 Hz
-	NM24263S	2400	10	100/378	5	4.58	220/380, 3-ph, 50/60 Hz
NWM31263S	NM31263S	3100	13	129/489	7.5	6.48	220/380, 3-ph, 50/60 Hz
NWM43263S	NM43263S	4300	17	179/678	7.5	6.48	220/380, 3-ph, 50/60 Hz
NWM55263S	NM55263S	5500	22	229/867	7.5	6.48	220/380, 3-ph, 50/60 Hz

When your needs demand continuous-duty, commercial-grade watermaking, the solution is crystal clear. The FCI Neptune Series is efficient and extremely reliable. These water systems deliver great volumes of fresh water with capacities of 1200 to 9500 GPD. Ideal for commercial vessels, island homes, oil platforms, hotels, or large yachts, a Neptune industrial water maker will provide wherever clean, pure, fresh water is needed. Employing FCI's pioneering UROC Technology, a Neptune commercial reverse osmosis unit enables advanced, total control and user-friendly system customization. Commercial necessities also include built-in cleaning ports on the framed units, washdown duty motors, 316SS high- and low-pressure pumps and commercial-sized pre-filters. Available in three configurations: Horizontal framed, Modular and the Wall-Mount system which combines the flexibility of modular installation with framed unit convenience. In addition, the Wall-Mount features uncompromised design, such as built-in pre-filters that slide out and lock back into place for easy maintenance. When your water demands are high and space is an issue, the wall-mount and modular series are a perfect fit. The entire Neptune series offers quality, dependability and years of worry-free operation in the most diverse marine environments.

Order No.	Mfg. No. / Description	Price
343213	(20-0019) Filter Cartridge - 5 Micron 2-1/2" x 9-3/4"	\$11.00 A
343216	(20-0020) Filter Cartridge - 20 Micron 2-1/2" x 9-3/4"	\$11.00 A
343219	(20-0025) Carbon Filter 2-1/2" x 9-3/4"	\$15.75 A
343223	(20-2261) Filter Cartridge - 5 Micron 5" x 13"	\$68.75 A
343226	(48-0199) Cat Pump Oil Pint	\$12.70 A
343229	(48-2374) Oil Pint	\$12.70 A

Fun & Flotation

Anchor & Dock

Safety

Electronics

Trolling Motors

Lighting

Electrical

Topside Acc.

Cockpit & Deck

Instruments

Steering, Controls

Perform.

Fuel System

Engine & Parts

Engine Care

Propellers

Seating & Pedestals

Tops & Covers

Pumps

Cleaning & Care

Paint & Paint Acc.

Hardware, Fasteners

Trailer

Misc.

Comm.

March Seal-Less Magnetic Drive Pumps



496631
496643



- For use submerged or in damp environments.
- Magnetic drive - no shaft seal to wear, leak, or replace.
- Extremely low energy consumption.
- March epoxy encapsulated circulating pumps with seal-less magnetic drive offer the ultimate in reliability.
- These versatile pumps are widely used on commercial and pleasure craft for recirculating sea water and for air conditioning and refrigeration.
- All models can be run in open air or submerged except model AC-5C-MD, which must be in a dry environment.
- All centrifugal pumps require a flooded inlet (suction side of pump).

SUBMERSIBLE PUMPS

Order No.	Mfg. No. / Description	Price
496605	(893-0001-040) 12 volt DC PH -	\$299.98 E
496629	(LC-2CP-MD) 115 volt 1 PH 50-60 Hz	\$347.98 E
496643	(LC-3CP-MD) 115 volt 1 PH 60 Hz	\$401.98 E
496655	(LC-5C-MD) 115 volt 1 PH 50-60 Hz	\$922.98 E
496631	(LC-3CP-MD230) 230 volt 1 PH 60 Hz	\$440.98 E
496667	(LC-5C-MD230) 230 volt 1 PH 50-60 Hz	\$1,014.98 E

NON-SUBMERSIBLE PUMPS - AIR COOLED

Order No.	Mfg. No. / Description	Price
496679	(150-0026-010) 115 volt 1 PH 50-60 Hz	\$393.98 E
496681	(150-136-01) 230 volt 1 PH 50-60 Hz	\$431.98 E

REPLACEMENT PARTS

Order No.	Mfg. No. / Description	Price
496719	(15000300100) Impeller for Series 5 Pumps	\$25.98 D

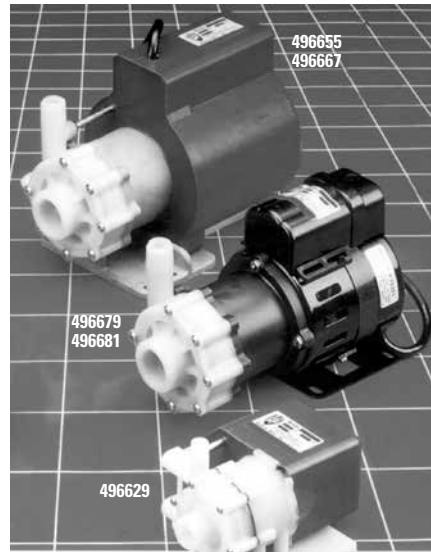

Model No.	Max. Flow GPM	Max. Head Ft.	Inlet	Outlet	HP	RPM	Volts	PH	Hz	Watts	Amp	Motor Type	Electrical Connection	Wt. Packed Lbs.
893-04	2.7	10.5	3/8" FPT	3/8" OD	1/150	4000	12	DC	-	12	1.0	TE/SUB	18' loose leads	1.2
893-06	2.7	10.5	3/8" FPT	3/8" OD	1/150	4000	24	DC	-	12	.5	TE/SUB	18' loose leads	1.2
LC-2CP-MD	5	13	3/8" FPT	1/4" MPT	1/35	3200	115	1	50/60	54	1.0	TE/SUB	6 ft. SJT	5
LC-3CP-MD	8.5	19	3/4" FPT	1/2" MPT	1/20	3200	115	1	60	120	2.35	TE/SUB	6 ft. SJT	8-1/2
LC-3CP-MD230	8.5	19	3/4" FPT	1/2" MPT	1/20	2450	230	1	60	78	.79	TE/SUB	6 ft. SJT	8-1/2
LC-5C-MD	14.5	27	1" FPT	1/2" MPT	1/8	2800	115	1	50/60	250	2.1	TE/SUB	6 ft. SJT	18
LC-5C-MD230	14.5	27	1" FPT	1/2" MPT	1/8	2750	230	1	50/60	143	.60	TE/SUB	6 ft. SJT	18
AC-5C-MD	17	27	1" FPT	1/2" MPT	1/8	3200	115	1	50/60	227	2.2	AC	3 ft. SJO	9-1/2
AC-5C-MD230	17	27	1" FPT	1/2" MPT	1/8	3200	115	1	50/60	260	1	AC	3 ft. SJO	9-1/2

Jabco Magnetically Coupled Centrifugal Pumps



- Magnetically Coupled Centrifugal Pumps for applications requiring safe, leak-free, continuous duty pumping.
- Designed specifically for marine and industrial markets.
- Typical applications include marine air conditioner circulation, ice makers, hot water circulation, livewell or bait tank installations.
- Pumphead manufactured in chemical resistant thermoplastics entirely non-metallic.
- Magnetic couplings provide an energy efficient thermal shield, minimizing heat transfer to the pumped fluid.
- IPX5 standard motor housing.
- Deep groove ball bearings.
- EPDM O-ring.
- Polypropylene (PP) encapsulated magnet.
- Polypropylene (PP) housing.
- PPS spindle housing.
- Alumina ceramic spindle.

Order No.	Mfg. No. / Description	Price
417244	(436977) 11 GPM	\$284.98 F
417246	(436979) 14 GPM	\$316.98 F
417248	(436981) 21 GPM	\$385.98 F

Polar Ware Stainless Steel Drain Fitting

- Highly polished.
- Diameter 1-1/2".
- Tail piece length 4".



Order No. Mfg. No. / Description
541068 (DUPLX/1H4FL)

Price
\$22.98 |

Johnson Pump Water Pressure Pump - 1.1 GPM

Johnson Pump

- Great for bar sinks.
- For single tap use.
- 1.1 GPM WPS Pump.
- Easy access, low maintenance.
- Self priming diaphragm style demand pump
- Can be mounted above water tank.
- 12 volt.
- Made in the USA.



Order No. Mfg. No. / Description
461957 (10-22020-101)

Price
\$80.98 Q

Jabsco Electric Galley Pump and Faucet

JABSCO



- Quiet operation electric pump is compact, draws 3 amps at 12 volts and pumps 1 GPM at 3 PSI.
- The attractive faucet has a stainless steel swing spout, easy-to-clean white plastic base and built-in switch to operate the pump.
- Pump and faucet have a 3/8" hose connection.
- The centrifugal pump is not self-priming and must be mounted below waterlevel of tank.
- Pump may be screwed directly into water tank.

Order No. Mfg. No. / Description
414398 (42510-0000) Pump Only
414401 (42530-0000) Pump and Faucet

Price
\$55.98 F
\$163.98 F

Polar Ware Self-Rimming Compartment Flat Rim Sink



- Buffed stainless steel.
- Deep drawn seamless construction.
- 20 gauge 18-8 satin finish with self-rimming bottom heavily undercoated for sound deadening.
- Dimensions: 10" x 14" ID, 13" x 17" OD and 6-1/2" D.
- Drain fitting not included, use **541068** (DUPLX/1H4FL).

Order No. Mfg. No. / Description
538061 (0173-8)

Price
\$249.98 LQ

Jabsco ParMax 1 Plus Faucet and Pump

JABSCO

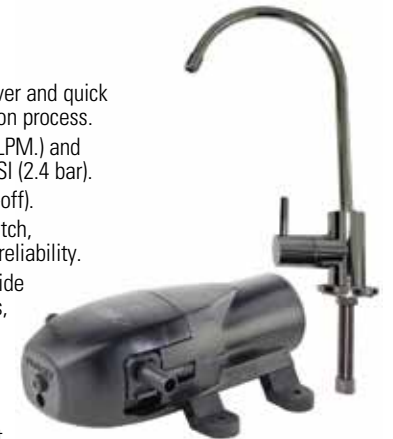

- IP (Ingress Protection) rated cover and quick fit ports improves the installation process.
- Flow rates up to 1.0 GPM (3.8 LPM.) and operating pressures up to 35 PSI (2.4 bar).
- Demand (pressure switch shut-off).
- Sealed motor and pressure switch, providing years of dependable reliability.
- Jabsco Diaphragm pumps provide dependable run dry capabilities, extending the life of the pump.
- Self-priming, accommodating up to 6 ft. (1.8m).
- Built in thermal protector, prevents overheating to protect the pump from damage.
- Quick disconnect ports allow for quick cleaning and easy hose replacement in seconds.
- Low amp draw, ideal for battery powered applications.
- John Guest type 1/4" to snap fit port (pump), 3/8" npt male to John Guest 1/4".
- Faucet included.

Order No. Mfg. No. / Description
417252 (42630-3992-P)

Price
\$119.98 G

Marpac Self-Contained Portable Toilets



- High-density polyethylene construction is corrosion proof.
- No external connections required.
- Fresh water bellows provides up to 50 easy-push flushes.
- Double seal valve eliminates leakage and odors.
- Quick emptying with easy-pour spout.
- Matte finish conceals scratches and is easy to clean.

Order No. Description
7-0009 2.6 Gallon - Includes: Hold Down Bracket
7-0010 5.2 Gallon
7-0007 Hold Down Bracket for **7-0009**

Price
\$99.98 F
\$124.98 G
\$19.98 G



7-0009



7-0010



7-0007

- Fun & Flotation
- Anchor & Dock
- Safety
- Electronics
- Trolling Motors
- Lighting
- Electrical
- Topside Acc.
- Cockpit & Deck
- Instruments
- Steering, Controls
- Perform.
- Fuel System
- Engine & Parts
- Engine Care
- Propellers
- Seating & Pedestals
- Tops & Covers
- Pumps
- Cleaning & Care
- Paint & Paint Acc.
- Hardware, Fasteners
- Trailering
- Misc.
- Comm.

- Fun & Flotation
- Anchor & Dock
- Safety
- Electronics
- Trolling Motors
- Lighting
- Electrical
- Topside Acc.
- Cockpit & Deck
- Instruments
- Steering, Controls
- Perform.
- Fuel System
- Engine & Parts
- Engine Care
- Propellers
- Seating & Pedestals
- Tops & Covers
- Pumps
- Cleaning & Care
- Paint & Paint Acc.
- Hardware, Fasteners
- Trailerling
- Misc.
- Comm.

Johnson AquaT™ Manual Compact Toilet

Johnson Pump®



- Made from white vitreous porcelain, and with corrosion resistant parts throughout, the AquaT marine toilet, is quiet, robust and easy to clean.
- Ergonomically designed, hand-powered piston pump that can be mounted for either left-hand or right-hand use.
- Innovative brake bushing prevents annoying leakage at the handle.

Order No.	Mfg. No. / Description	Price
470079	(80-47229-01)	\$191.98 G

Johnson AquaT™ Silent Electric Compact Toilet

Johnson Pump®



- Made from white vitreous porcelain, and with corrosion resistant parts throughout, the AquaT marine toilet, is quiet, robust and easy to clean.
- Equipped with 12 volt Aqua Jet pump.
- Versatile plumbing connection options.
- Automatic back-flow prevention.
- Complies with ISO 8846, ignition protection and EN 55014 EMC.
- Hygienic, easy-to-clean vitreous china bowl and exterior surfaces.
- Low water consumption (2-2.5 l/flush) makes the most of holding tank capacity.
- May be installed above or below the waterline.
- 12 volt.

Order No.	Mfg. No. / Description	Price
470081	(80-47231-01)	\$549.98 G

Raritan Model PHII Hand Toilet



- The PHII's inlet valve can provide either simultaneous intake and discharge or dry flush.
- The pump can be mounted for use with either left or right hand.
- Constructed with only the finest plastic, stainless steel and buna "N" rubber.
- Standard size bowl.
- Outlet hose ID 1-1/2".
- Inlet hose ID 3/4".
- Dimensions: 14-1/6" H x 18-3/16" W x 16-1/4" D.
- 30 lbs.

Order No.	Mfg. No. / Description	Price
564179	(PHII) Hand Toilet	\$489.98 D
564183	(PHRK II) Repair Kit, Post 1992	\$72.98 F
564624	(1238A) Standard Seat and Cover	\$42.98 F

Johnson AquaT™ Standard Electric Compact Toilet

Johnson Pump®



- Made from white vitreous porcelain, and with corrosion resistant parts throughout, the AquaT marine toilet, is quiet, robust and easy to clean.
- Equipped with a combined pump unit for disposal and flushing.
- Automatic back-flow prevention.
- Wooden seat.
- Carling switch panel.
- Complies with ISO 8846, ignition protection and EN 55014 EMC.
- Low water consumption (2-2.5 l/flush) makes the most of holding tank capacity.
- May be installed above or below the waterline.
- Designed to be direct replacement for Jabsco.
- 12 volt.

Order No.	Mfg. No. / Description	Price
470083	(80-47435-01) Macerator Style	\$453.98 G

Johnson Pump Toilet Accessories

Johnson Pump®



CONTROL PANEL

- For Standard Electric Toilets 12V/24V.

Order No.	Mfg. No. / Description	Price
470085	(81-36105-01)	\$102.98 G

VENTED LOOPS

Order No.	Mfg. No. / Description	Price
470086	(81-47237-01) 3/4"	\$53.98 G
470087	(81-47237-02) 1"	\$72.98 G
470088	(81-47237-03) 1-1/2"	\$42.98 G

Y-VALVE

Order No.	Mfg. No. / Description	Price
470089	(81-47238-01) 1-1/2" Inner Diameter, 1" Straight	\$94.98 G

Raritan Atlantes Freedom Electric Toilet



- Commercial grade.
- One piece china bowl.
- Simple flexible installation.
- Low power consumption.
- Anti-clog "power shred" discharge system.
- Three modes of operation: Fill, dry flush or fill and flush.
- Handle with timer operation has "fail-safe" mode.
- Diaphragm intake pump can be run dry.
- Microprocessor control and solid state circuit breaker.
- No fuses or relays inside the unit.

Order No.	Mfg. No. / Description	Price
563830	(AVHWR01203)	\$1,598.98 F

Raritan Crown Head Electric Toilets



- The Crown Head features a single motor that drives both the intake and discharge pumps, and a sturdy bronze housing for the macerating section.
- It can be installed above or below the waterline and the 12V model draws only 36 amps with an average required flush time of 10 seconds using only 1 quart of water.
- 12 volt.

Order No.	Mfg. No. / Description	Price
563937	(C912) Marine-Size, Standard	\$1,399.98 D
563930	(CW912) Household-Size	\$1,427.98 D
563963	(CHRK) Standard Repair Kit	\$119.98 F
564624	(1238A) Standard Seat and Cover	\$42.98 F

Jabsco Twist 'n' Lock Manual Toilet



- Twist 'n' Lock safety handle and flush control lever.
- Powerful swirl action for efficient flushing.
- Full sized external seal housing allows quick clean seal replacement and instant access to pump cylinder.
- Constant 1-1/2" bore waste pipe.
- Crevice free contours and smooth mouldings for added hygiene.
- Reversible pump mounting for choice of right or left handed installation.
- Stylized luxury wooden seat and cover with tough baked enamel coating.
- Automatic vacuum breaker for easier pumping.
- Powerful self-priming pump for above or below waterline installation.
- Angled pump housing and long stroke for ease of installation.
- Dimensions: 17-3/4" W x 16" D x 13-1/2" H.

Order No.	Mfg. No. / Description	Price
414906	(29090-3000) Compact Bowl	\$209.98 F
414920	(29045-0000) Service Kit, Up to 1997	\$80.98 F
414932	(29045-2000) Service Kit, From 1998 to 2007	\$78.98 F

Jabsco Deluxe Flush Electric Toilet



- The stylish and extremely compact design is carefully contoured to conceal the flush pump, wiring and plumbing, whilst still featuring a full-size household seat.
- The 17" Slanted Back gives minimal footprint and makes it easy to mount against a sloping surface or in a corner.
- Features a multifunction 'one touch' control pad offering 4 rinse and flush options, using as little as 1.5 US quarts of water.
- This model supplied with solenoid valve and siphon breaker assembly for connection to any existing pressurized water system capable of delivering 2.9 US gpm (11 lpm) or more.
- The siphon breaker ensures there is no backflow from the toilet into the water system.
- Complies with USCG 183.410 and ISO 8846 MARINE (Ignition protection).
- 12 volt.

Order No.	Mfg. No. / Description	Price
414982	(58020-1012)	\$918.98 F

Raritan Parts for Crown Head II Electric Toilet



Order No.	Mfg. No. / Description	Price
563848	(CWPS12B) Water Solenoid, 12 Volt	\$177.98 F
563968	(G13W) Intake Pump Impeller with Teflon Washers	\$34.98 F
564059	(CH-102MW) Crown Head Pump	\$229.98 F
564069	(CH-18W) Front Cover with O-Ring	\$46.98 F
564077	(C253) Joker Valve for Most Raritan Toilets	\$20.98 F

Jabsco Electric Marine Toilets



- Hygienic pure white vitreous china bowl for easy cleaning.
- Stylized luxury wooden seat and cover with tough baked enamel coating.
- Stainless steel and bronze fastenings for reliable saltwater service.
- Flushing pump self-priming up to 4'.
- May be mounted 3' below the waterline.
- Built-in back flow preventer.
- Equally suitable for overboard or holding tank discharge.
- 12 volt.
- Complies with USCG 183.410 and ISO 8846 MARINE (Ignition protection).

COMPACT SIZE TOILET

Order No.	Mfg. No. / Description	Price
414956	(37010-0090) 14" H x 13-7/8" W x 17-5/8" L	\$562.98 F

HOUSEHOLD (REGULAR) SIZE TOILET

Order No.	Mfg. No. / Description	Price
414970	(37010-1090) 14-5/8" H x 14-3/4" W x 18-1/2" L	\$541.98 F

REPAIR KITS AND REPLACEMENT PARTS

Order No.	Mfg. No. / Description	Price
415011	(37040-0000) Service Kit - Seals and O-rings	\$61.98 F
415023	(37041-0010) Replacement Pump Assembly, 12 volt	\$281.98 E
415035	(37064-0000) Replacement Motor, 12 volt	\$180.98 E

Jabsco Electric Toilet Base Assembly



- Convert our Manual Toilet Compact and Regular bowl models to full electric operation without need to alter existing inlet or discharge seacocks.
- Also converts most toilets with 4 bolt screw pattern on a 3-3/4" diameter bolt circle such as Groco, Raritan, Wilcox Crittenden, Mansfield and Sealand.
- Flushing pump self-priming up to 4' vertical lift.
- A built-in backflow preventer is included in discharge.
- A heavy duty push button switch and 1" to 1-1/2" hose adaptor for the discharge port plus all clamps and fasteners to complete the conversion are included.
- 12 volt.

Order No.	Mfg. No. / Description	Price
415085	(37010-0092) Inlet 3/4", Discharge 1"	\$488.98 E

- Fun & Flotation
- Anchor & Dock
- Safety
- Electronics
- Trolling Motors
- Lighting
- Electrical
- Topside Acc.
- Cockpit & Deck
- Instruments
- Steering, Controls
- Perform.
- Fuel System
- Engine & Parts
- Engine Care
- Propellers
- Seating & Pedestals
- Tops & Covers
- Pumps
- Cleaning & Care
- Paint & Paint Acc.
- Hardware, Fasteners
- Trailering
- Misc.
- Comm.

- Fun & Flotation
- Anchor & Dock
- Safety
- Electronics
- Trolling Motors
- Lighting
- Electrical
- Topside Acc.
- Cockpit & Deck
- Instruments
- Steering, Controls
- Perform.
- Fuel System
- Engine & Parts
- Engine Care
- Propellers
- Seating & Pedestals
- Tops & Covers
- Pumps
- Cleaning & Care
- Paint & Paint Acc.
- Hardware, Fasteners
- Trailer
- Misc.
- Comm.

Raritan Electro Scan® Type I Marine Sanitation Device



- The most popular USCG certified Type I MSD.
- Generates its own natural disinfectant from salt water.
- Coated electrodes use salt water to kill bacteria and viruses without harmful chemicals.
- Records each treatment cycle and stores key information in non-volatile memory that can be summarized on the LCD display or downloaded to a PC.
- Single button operation is possible and can be used with both manual and electric toilets.
- Requires sea water for salinity or salt feed tank.
- 12 volt.

Order No.	Mfg. No. / Description	Price
564054	(EST12)	\$1,570.98 D

Marpac Macerator Pump



- Self-priming up to 6' with superior performance up to 10 GPM.
- Direct replacement for Jabsco, Johnson and Shurflo.
- Rotary cutter shreds waste before it is pumped into or out from the holding tank.
- 1-1/2" hose or NPT waste inlet, 1" hose discharge outlet.
- Heavy duty 12 volt motor.
- 1 year warranty.
- Made in USA.

Order No.	Description	Price
7-0901	Macerator Pump	\$123.98 G

Jabsco Macerator Waste Pump - DC Voltage



- Self-priming to 4' vertical lift.
- Triple sealed motor to prevent both internal and external motor corrosion.
- New four-bladed chopper reduces clogging
- Sensor provides adequate run-dry period to allow initial priming of the pump.
- Complies with USCG Regulation 183.410 and ISO 8846 MARINE.
- 12 volt.

Order No.	Mfg. No. / Description	Price
415154	(18590-2092)	\$202.98 F

Raritan Purasan Tablets & Retro-Fit Kit



- This kit is required for the first time you need to order replacement tablets for an older Purasan system.
- If your Purasan uses 41-135, then this kit will upgrade the dispenser to the new version and replacement tablets in the future will be 41-135A
- Purasan Tablets - These are used in the NEW PST12EX or PST24EX.
- Users of the original PST12 or PST24 - if this is the first time ordering replacement tablets, you MUST order the 564194 (41-135RFK) the first time then simply order the 564199 (41-135A) on subsequent orders.

Order No.	Mfg. No. / Description	Price
564194	(41-135RFK) Retro-Fit Kit	\$89.98 F
564199	(41-135A) Purasan Tablet Cartridge	\$60.98 F

Johnson Pump Macerator Pumps



- The TA3P10-19 macerator pump takes care of toilet waste.
- A rotary cutter shreds waste before it is pumped into or out from the holding tank.
- 10 GPM.
- Outlet connection: 1" hose.
- Inlet connection: 1-1/2" hose or 1-1/2" NPT.
- The pump should be connected as close as possible to the holding tank discharge outlet or the bowl discharge outlet.
- Note! Use unbleached lavatory paper only.

Order No.	Mfg. No. / Description	Price
470170	(10-24453-01) 12 volt	\$181.98 R
4610047	(10-24453-01) 12 volt	\$156.98 LQ
470174	(10-24453-02) 24 volt	\$205.98 R

Jabsco Heavy Duty Macerator Pump - 115V AC Voltage



- Flow rate to 14 GPM.
- Self-priming to 4'.
- Permitting the unit to be mounted above or below the tank in a convenient location.
- Thermal overload protection motor.
- Ports: Inlet - 1-1/2" external pipe thread; Outlet - 1" ID hose barb.
- Dimensions: 8" H x 7-1/4" W x 14-7/8" L.
- 115V AC.

Order No.	Mfg. No. / Description	Price
415174	(18690-0000)	\$786.98 F
415162	(18598-1000) Service Kit	\$69.98 F

Jabsco Waste Evacuation Pump



- Robust diaphragm pump passes solids and is particularly effective in emptying holding tanks.
- The multi-positional pump head offers a variety of installation options.
- Compact and simple design. Quiet running.
- Flexible installation.
- 5 GPM output.
- Self-priming up to 10'.
- Capable of extensive dry running.
- Connections for 1-1/2" ID hose.
- 12 volt.

Order No.	Mfg. No. / Description	Price
415136	(50890-1000)	\$306.98 F

Johnson Pump Viking Power 16 Diaphragm Pump



- A modern, single-chamber self-priming diaphragm pump that can be set up in several different pump/motor configurations.
- Self priming to about 10'.
- It is easy to install anywhere after the drain outlet in the wastewater system or as a bilge pump.
- The low pulse and muffled rubber bracket offer quiet operation.
- The pump can be run dry, and handle a mixture of air and water easily.
- Connection" KlickTite XL connectors for 1" hose or 3/4" hose and 1/2" BSP threads.
- Non-choke valves means that no in-line filters are necessary.
- Works with optional gray water tank 09-13384.
- 4.2 GPM.
- 12 volt.

Order No.	Mfg. No. / Description	Price
461951	(10-13350-03)	\$265.98 Q

Johnson Pump Viking Power 32 Waste Pump



- Designed to meet the rigorous demands.
- Thanks to its single chamber design and non-choke valves, it can be used to pump un-macerated sewage to a holding tank or transfer it onwards to a septic tank.
- It can handle a mixture of air and water without difficulty and un-macerated sewage to a holding tank.
- Includes a hand crank in case of emergency.
- 8.5 GPM.
- Connection 1-1/2".
- 12 volt.

Order No.	Mfg. No. / Description	Price
461952	(10-13373-03)	\$360.98 Q

Johnson Pump Gray Water Tank



- Designed to be used as collection tank for waste water from showers, sinks, dishwashing machines, etc. with 19 mm, 25 mm, and 38 mm inlet ports and 19 mm and 25 mm outlet ports.
- The tank includes the Ultima Switch for automatic operation and is easy to connect to any 12V/24V pump up to 20 amp.
- The tank is prepared for the Viking 16 Pump with pre-drilled holes for the pump.

Order No.	Mfg. No. / Description	Price
462330	(09-13384)	\$352.98 G

Moeller Waste Tanks



- A vast array of combo water/waste tank sizes ensures you the right fit for your vessel needs.
- Feature nominal wall thickness of 0.300" (7.6mm).
- Resin meets FDA spec CFT177 1520 requirements.
- Satisfies all U.S. Coast Guard standards.
- Provides standard NPT openings for vent, fill and drain.
- Polyethylene tanks will not filter taste into water or emit waste odors.

Order No.	Mfg. No. / Description	Price
666961	(041206) 5 Gallon 16" L x 11-3/4" W x 8" H	\$132.98 F
666973	(041209) 9 Gallon 17" L x 13-3/4" W x 10-1/4" H	\$138.98 F
667014	(041220) 20 Gallon 21" L x 17" W x 14" H	\$225.98 F
667038	(041230) 30 Gallon 28" L x 23" W x 11-1/2" H	\$284.98 F

Groco Vented Loops



- All bronze construction.
- For hose connections.
- Suitable for engine exhaust system installations or sanitation system installations.
- Oversized vent valve virtually clog-free and can easily be removed without tools for inspection cleaning by unscrewing the threaded cap.

Order No.	Mfg. No. / Description	Price
S/O	(HVL-750) Hose ID 3/4"	Price on Request
375103	(HVL-1000) Hose ID 1"	\$121.98 G
S/O	(HVL-1500) Hose ID 1-1/2"	Price on Request

Forespar Vented Loops for Waste Line



- Molded in glass reinforced Marelon.
- The simple valve system incorporated in the top of the loop allows air to enter the line when not in use, yet effectively seals as water or other fluid passes through.
- If your toilet is set below the waterline, a vented loop should be installed to prevent back siphoning.

Order No.	Mfg. No. / Description	Price
353425	(903001) Barb 3/4" 4-1/2" H, 3-3/4" W	\$32.98 F
353437	(903000) Barb 1-1/2" 5-1/4" H, 7-3/4" W	\$36.98 F

- Fun & Flotation
- Anchor & Dock
- Safety
- Electronics
- Trolling Motors
- Lighting
- Electrical
- Topside Acc.
- Cockpit & Deck
- Instruments
- Steering, Controls
- Perform.
- Fuel System
- Engine & Parts
- Engine Care
- Propellers
- Seating & Pedestals
- Tops & Covers
- Pumps**
- Cleaning & Care
- Paint & Paint Acc.
- Hardware, Fasteners
- Trailering
- Misc.
- Comm.

Forespar 1-1/2" Y-Valve



- Molded from glass reinforced Marelon.
- When installed in waste systems, the waste can be pumped directly into a holding tank or diverted to an overboard discharge fitting.
- The valves are operated by a simple 120° movement.
- Positive stops are provided between positions.
- Barb 1-1/2".

Order No.	Mfg. No. / Description	Price
353451	(902000)	\$73.98 F

Jabsco 1-1/2" Y-Valve



- Robust Y-valve for use in bilge applications.
- Allows two bilge sections to be emptied by one pump.
- Connections for with both 1-1/2" ports and extra 1" straight inlet port.
- Waste and corrosion resistant construction throughout.

Order No.	Mfg. No. / Description	Price
415201	(45490-1000)	\$84.98 G

Perko Fig. 1269 Waste Deck Plate for Hose



- Chrome plated zinc alloy.
- Black polymer cap.
- Deck plate key and O-ring included.
- Deck plate with cap marked "Waste".
- For 1-1/2" hose.
- Length of neck is 2-1/2".
- Flange OD 3-1/4".
- Uses #8 fasteners.
- Cap has holes and a slot for key, screw driver or large coin.

Order No.	Mfg. No. / Description	Price
540165	(1269 DPO CHR)	\$44.98 R
540166	(1269 DPO 99A) Cap Only	\$13.98 R

Perko Fig. 524 Waste Deck Plate for Pipe



- Chrome plated bronze.
- Marked "Waste".
- Deck plate key and O-ring included.
- Cap has a slot between the holes.
- For pipe size: 1-1/2".
- Flange OD 3-5/8".
- Uses #8 fasteners.
- Note: Complies with adopted standards on "fittings" ABYC Recommended Practices Standards Covering Sewage Holding and/or Treatment Device for Marine Waste Systems.

Order No.	Mfg. No. / Description	Price
540155	(0524 DPO CHR)	\$150.98 LQ

MPI Products Series 148 White Sanitation Hose

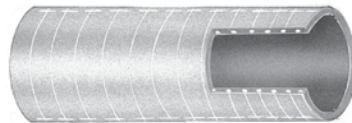

- VAC rating is 28.
- White.
- Smooth wall extra heavy duty vinyl hose for all sanitation system connections and other critical applications.
- FDA approved and low water absorption compounds provide excellent odor resistance.
- 50' box.

Order No.	Mfg. No. / Description	Price
771407	(148-0346) 3/4"	\$104.98 H
771419	(148-1006) 1"	\$121.98 H
771421	(148-1186) 1-1/8"	\$137.98 H
771433	(148-1146) 1-1/4"	\$157.98 H
771445	(148-1126) 1-1/2"	\$169.98 H

Marpro Instant Fresh Toilet and Holding Tank Treatment



- Heavy duty formula quickly eliminates odors.
- Fresh lemon scent.
- Breaks down waste and tissue paper.
- Formaldehyde free, safe formula.
- Lubricates, prevents drain valves from sticking.

Order No.	Description	Price
7-2727	8 oz., Sold 4 Pack Only	\$15.98 Q
7-2728	32 oz.	\$8.98 Q
7-2729	64 oz.	\$19.98 Q

Camco TastePURE™ Drinking Water Freshener



- Eliminate algae and slime buildup from drinking water tanks.
- Just one ounce helps remove bad smells and taste from 20 gallons of water.

Order No.	Mfg. No. / Description	Price
583701	(40208) 16 fl. oz.	\$6.98 F

Camco Fresh Water Dewinterizer



- For use with boats or RVs coming out of storage.
- Just one bottle freshens and deodorizes your Fresh Water System from tank to tap.
- Treats up to 60 gallons.

Order No.	Mfg. No. / Description	Price
583155	(40218) 16 fl. oz.	\$18.98 R

- Fun & Flotation
- Anchor & Dock
- Safety
- Electronics
- Trolling Motors
- Lighting
- Electrical
- Topside Acc.
- Cockpit & Deck
- Instruments
- Steering, Controls
- Perform.
- Fuel System
- Engine & Parts
- Engine Care
- Propellers
- Seating & Pedestals
- Tops & Covers
- Pumps
- Cleaning & Care
- Paint & Paint Acc.
- Hardware, Fasteners
- Trailering
- Misc.
- Comm.

MSD Activator

Order No.	Mfg. No. / Description	Price
264313	(1210) Quart	\$39.98 F

Bacteria Kit

Order No.	Mfg. No. / Description	Price
596085	(MANOWAR)	\$136.98 E

Man O War Enhancer

Order No.	Mfg. No. / Description	Price
596090	(ENH)	\$80.98 E

Marpac Mega Rolls Toilet Tissue



- Premium quality 2 ply sheets.
- Biodegradable.
- 100% recycled materials.
- Resealable pouch.
- Dissolves quickly.
- 2 rolls per package.

Order No.	Description	Price
7-2731	500 Sheets	\$7.98 Q

AHEAD MSD Activator



- Degrades tissue, detergent, paper, fat, oil and grease.
- Restores the natural biological process.
- Boosts the existing biological activity.
- Keeps your system working efficiently.
- Prevents expensive emergencies.
- Helps keep system trouble free.
- Improves organic waste degradation.
- Reduces odors and solids.

Order No.	Mfg. No. / Description	Price
242911	(MSDACT) Tub Contains (20) 1 oz. Packets	\$65.98 E

Billiot Pools Chlorine Tablets

Order No.	Mfg. No. / Description	Price
256330	(1" CHL TAB 2) 1" 25#	\$166.98 LQ



Chlorine Tablets

Order No.	Mfg. No. / Description	Price
596088	(CZ-CLTAB10) 10#	\$111.98 E

AHEAD Tank™ Marine Sanitation Device



- A simple, easy to use, and long lasting solution to the problem of sewage treatment for recreational and commercial boating.
- Constructed of heavy duty polyethylene using a new cutting edge rotary molding process which enables the formation of multi-treatment chambers into the internal structure of one tank.
- It will not corrode, rust, or breakdown under any natural condition.
- Exceeds all of the compliance criteria regulating the industry, making it the #1 MSD in the #2 business.
- Acceptable for use on Inspected and Uninspected Vessels as defined in USCG 33 CFR 159.3 and IMO Resolution MEPC.2(VI).

Order No.	Mfg. No. / Description	Price
242905	(AT-6T) Flow Rate 56 Gallons	\$4,381.98 C
242907	(AT-12) Flow Rate 88 Gallons	\$6,631.98 C
242909	(WWDS 6/12 MA) Behind Tank - 110 volt, 6/12 Man	\$1,006.98 C

AHEAD MSD Enhancer and Odor Controller



- Increase Bacterial Metabolism by up to 1000%.
- Eliminates foul odor in the worst conditions.
- Increases sewage system efficiency.
- Promotes bacterial growth in fresh or salt water.
- Fast acting and biodegradable.
- Completely safe to the environment.

Order No.	Mfg. No. / Description	Price
242913	(MSDENH) 32 fl. oz.	\$57.98 E

- Fun & Flotation
- Anchor & Dock
- Safety
- Electronics
- Trolling Motors
- Lighting
- Electrical
- Topside Acc.
- Cockpit & Deck
- Instruments
- Steering, Controls
- Perform.
- Fuel System
- Engine & Parts
- Engine Care
- Propellers
- Seating & Pedestals
- Tops & Covers
- Pumps
- Cleaning & Care
- Paint & Paint Acc.
- Hardware, Fasteners
- Trailering
- Misc.
- Comm.



MARINE

Wastewater Treatment Systems for Small Boats and Offshore

PATENTED - PROVEN - U.S.C.G. CERTIFIED TYPE II MSD

The OWENS KLEEN TANK is a self-contained "extended aeration" biological system that is ready for operation when site electrical and mechanical connections are in place. The KLEEN TANK small boat models can be designed to fit small, hard to fit areas and have a capacity range from 33 GPD to thousand of gallons per day. Easy maintenance, long lasting reliability and optimum effluent compliance make the KLEEN TANK the educated choice for marine sanitation devices.

- Fun & Flotation
- Anchor & Dock
- Safety
- Electronics
- Trolling Motors
- Lighting
- Electrical
- Topside Acc.
- Cockpit & Deck
- Instruments
- Steering, Controls
- Perform.
- Fuel System
- Engine & Parts
- Engine Care
- Propellers
- Seating & Pedestals
- Tops & Covers
- Pumps
- Cleaning & Care
- Paint & Paint Acc.
- Hardware, Fasteners
- Trailering
- Misc.
- Comm.

CONSTRUCTION

- Constructed of Carbon Steel or Stainless
- Patented Floating Skimmer
- Seam Welded
- Upflow Gravel Bed Filter w/Backwash System
- Sandblasted to near white metal
- Easy Access Covers
- Corrosion Protected
- Easy Access / Non-Corrosive Valve Controls
- Coal Tar Epoxy inside
- Low Maintenance Disinfection System
- 3-Part Polyurethane Paint System outside
- Alarm System (optional)
- Stainless Steel weir basket - self cleaning
- Nationwide Single Source Supplier for Repair Parts
- Regenerative Blower TEFC - quiet (optional)
- Exterior Mounted Filter Cleaning Valve
- Float Controlled Effluent Pump (optional)

SIZED TO DO THE JOB

Model (small boat)	Gallons	Crew Size	Dimensions (H x W x L)	Mt. Wt. (Approx.)
A	33	3	3.5 x 1 x 3	400
A *Lowboy	33	3	2.5 x 1.5 x 3	400
B	76	6	3.5 x 1.5 x 4.5	500
C	112	10	3.5 x 2 x 6	800
D	182	16	4 x 2 x 7	1105
E	240	20	4.5 x 2 x 8	1317
F	360	32	4.5 x 3 x 8	1550
G	450	40	6 x 3 x 8	2050
H	750	62	6 x 4 x 10	2230
I	900	80	6 x 4 x 12	3296
J	1125	100	6 x 5 x 12	4668

ALL UNIT APPLICATION SIZING (CREW SIZE) IS BASED ON:

1. Low Flush Toilets. 1-1/2 Gallons/Flush
2. 24 hour Occupancy
3. BLACKWATER ONLY. FOR OTHER APPLICATIONS CONSULT FACTORY.

*** Modified size for easy placement on vessels. Models C-J are skid mounted. Add 4" to height and 6" to length for overall dimensions.**

NOTES:

1. Standard units are constructed of carbon steel plate. Stainless Steel or aluminium plants are also available, consult factory for prices.
2. Explosion proof or 3 phase equipment available on special order, consult factory.
3. Larger & Special units are available by Special order. Designs to fit most small and hard to fit areas also available upon request.
4. U.S.C.G. certified as Type II MSD/33CFR 159.15 Under OWENS KLEEN TANK, Certification #159.1038/5/11

KLEEN TANK 4-POINT EASY MAINTENANCE PLAN

1. Every two weeks - add Formula 101 to toilet
2. Every two weeks - add chlorine as required
3. Once a month - clean external up-flow filter by opening the external fluffer valve for 5 minutes
4. Every six months - replace inlet air filter

CALL FOR PRICING AND AVAILABILITY

101 Formula 5 lb. Pail

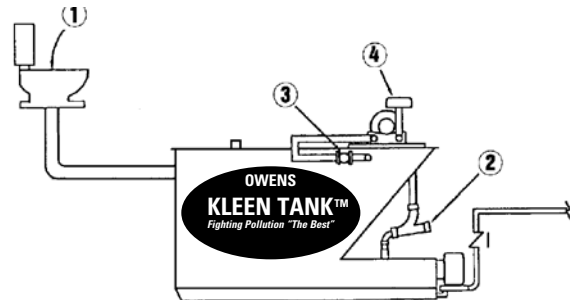

Order No.	Mfg. No. / Description	Price
202464	(5LB PAIL)	\$116.98 F

Rule Tournament Series Dual Port Livewell Pump



- Glass filled nylon dual port base for optional washdown pump connection..
- Anti-airlock feature.
- Heavy duty long life motors.
- Silent running and vibrationless.
- The pump has a 1" NPT female intake, 1-1/8" discharge outlet and a 1/2" NPT threaded port for washdown installation.
- 1,600 GPH.
- 12 volt.



Order No.	Mfg. No. / Description	Price
581733	(209FDP)	\$184.98 F

Rule Tournament Series Bronze Base Livewell Pump



- Features a bronze base.
- Anti-airlock feature.
- Heavy duty long life motors.
- Silent running and vibrationless.
- 1,600 GPH.
- 1" NPT female intake.
- Discharge 1-1/8".
- 1,600 GPH.
- 12 volt.



Order No.	Mfg. No. / Description	Price
581745	(209B)	\$191.98 F

Rule "C Tournament" Series Livewell/Aerator Pumps



- Discharge nozzle can be rotated 360° for optimal installation.
- Pump housing can rotate 360° to allow positioning of discharge outlet.
- Quick one hand "push button" motor cartridge removal system.
- Dual port fitting for optional washdown pump.
- Angled pick-up with straight thread.



Order No.	Mfg. No. / Description	Price
581757	(401C) 500 GPH	\$55.98 F
581810	(403C) 800 GPH	\$58.98 F
581874	(405C) 1,100 GPH	\$64.98 F

Rule "FC Tournament" Series Livewell/Aerator Pumps



- Discharge nozzle can be rotated 360° for optimal installation.
- Pump housing can rotate 360° to allow positioning of discharge outlet.
- Quick one hand "push button" motor cartridge removal system.
- Dual port fitting for optional washdown pump.
- Tapered thread for seacock application.



Order No.	Mfg. No. / Description	Price
581856	(401FC) 500 GPH	\$50.98 F
581858	(403FC) 800 GPH	\$52.98 F
581872	(405FC) 1,100 GPH	\$58.98 E

Rule "STC Tournament" Series Livewell/Aerator Pumps



- Discharge nozzle can be rotated 360° for optimal installation.
- Pump housing can rotate 360° to allow positioning of discharge outlet.
- Quick one hand "push button" motor cartridge removal system.
- Dual port fitting for optional washdown pump.
- Straight pick-up with straight thread.



Order No.	Mfg. No. / Description	Price
581769	(401STC) 500 GPH	\$55.98 F
581860	(403STC) 800 GPH	\$57.98 F
581875	(405STC) 1,100 GPH	\$64.98 F

Rule Replacement Motor Cartridges for Tournament Series

- Quick one hand "push button" motor cartridge removal system.



Order No.	Mfg. No. / Description	Price
582088	(45DR) 500 GPH	\$36.98 R
582090	(46DR) 800 GPH	\$45.98 R
582103	(47DR) 1,100 GPH	\$48.98 G

Rule Replacement Motor Cartridges for Original Pro-Series Livewell Pumps

- For all Pro-Series Aerator Pumps.
- Fits older Rule Aerator Pumps. Old Style.



Order No.	Mfg. No. / Description	Price
5815021	(25DR) 500 GPH	\$33.98 H
581859	(20RR) 700 GPH	\$41.98 G
581884	(27DR) 1,100 GPH	\$44.98 F

Shurflo Piranha™ Straight Port Aerator Pump - 600 GPH



- High density nylon housing.
- Heavy duty water cooled motor.
- Anti-airlock.
- Submersible.
- Removable cartridge for easy cleaning.
- Includes 6' tinned wire assembly.
- 3/4" ports.
- 600 GPH.
- 12 volt.



Order No.	Mfg. No. / Description	Price
353110	(357-012-10) 9.5" x 3.75"	\$51.98 G
353115	(94-005-00) Replacement Cartridge	\$30.98 G

Shurflo Bait Sentry™ Livewell Pumps



- Magnetically-driven impeller, debris will not damage motor.
- Anti-airlock feature will clear trapped air even in rough water.
- Second inlet port for washdown pump, requires one thru-hull fitting for two pumps.
- No seals to leak, can run dry continuously.
- Tank size: 30 gallon.
- 12 volt.



Order No.	Mfg. No. / Description	Price
353114	(1700-001-030) 500 GPH 3/4" Inlet 3/4" Outlet	\$108.98 G
353116	(1700-011-030) 800 GPH 3/4" Inlet 3/4" Outlet	\$113.98 G
353117	(1700-021-030) 1,100 GPH 3/4" Inlet 1-1/8" Outlet	\$121.98 G

- Fun & Flotation
- Anchor & Dock
- Safety
- Electronics
- Trolling Motors
- Lighting
- Electrical
- Topside Acc.
- Cockpit & Deck
- Instruments
- Steering, Controls
- Perform.
- Fuel System
- Engine & Parts
- Engine Care
- Propellers
- Seating & Pedestals
- Tops & Covers
- Pumps**
- Cleaning & Care
- Paint & Paint Acc.
- Hardware, Fasteners
- Trailering
- Misc.
- Comm.

- Fun & Flotation
- Anchor & Dock
- Safety
- Electronics
- Trolling Motors
- Lighting
- Electrical
- Topside Acc.
- Cockpit & Deck
- Instruments
- Steering, Controls
- Perform.
- Fuel System
- Engine & Parts
- Engine Care
- Propellers
- Seating & Pedestals
- Tops & Covers
- Pumps
- Cleaning & Care
- Paint & Paint Acc.
- Hardware, Fasteners
- Trailer
- Misc.
- Comm.

Marpac Livewell Pumps - Cartridge Type



- Anti-airlock feature keeps water flowing.
- Removable powerhead design.
- Extended life water cooled motor.
- Lightweight glass resin composite impeller resists breakage.
- Thermoplastic housing resists heat and stress.
- High grade 316 stainless steel shaft.
- Just lift a tab and remove the motor to clean.
- Straight and omni-directional 90° hose barbs.
- Easy installation and easy to clean.
- Quick change motor cartridge replacement (Order No. 7-2218).
- 3/4" OD discharge port.
- 3/4" Straight thread NPS.

Order No.	Description	Price
7-2216	750 GPH, In-line with Standard 3/4" Outlet	\$50.98 G
7-2214	750 GPH, 90° Inlets with Standard 3/4" Outlet	\$46.50 G
7-2218	Replacement Motor Cartridge	\$33.98 G

Johnson Pump Twin Port Aerator/Livewell Pumps



- Twin port pumps offer the convenience of using only the one intake for both the livewell and raw water washdown pump.
- The 3/4" tapered inlet connects directly to the seacock and the upper outlet port provides a continuous flow of water through the 3/4" discharge to the livewell while the lower outlet port connects to the washdown pump through either a 1/2" or 3/4" ports.
- New high pressure inlet seal easily handles the higher pressures created by high speed pickups commonly used.
- Note can also keep in the plug on second port and use as aerator for tight applications that can use NPT thread.
- Made in the USA.
- 12 volt.

Order No.	Mfg. No. / Description	Price
470725	(48503) 500 GPH	\$48.98 LQ
470162	(48503) 500 GPH	\$49.98 R
470839	(48703) 750 GPH	\$57.98 Q
470729	(48903) 1,000 GPH	\$59.98 Q
470166	(48903) 1,000 GPH	\$59.98 R

Johnson Pump Spare Motor Cartridges



- Replacement fits all Johnson Pump universal cartridge housings like aerators, bilge, twinport, or lowboy pumps.

Order No.	Mfg. No. / Description	Price
470740	(28552) Spare Motor Cartridge for 500 GPH	\$24.98 H
470738	(28572) Spare Motor Cartridge for 750 GPH	\$40.98 H
470745	(42522) Spare Motor Cartridge for 1,250 GPH	\$47.98 H

Attwood Tsunami Series Cartridge Aerator Pumps



- Innovative engineering and compact design, Tsunami pumps deliver high output from a small package.
- Move more water and oxygen into livewell tanks to keep fish active.
- Cooler-running motors, premium materials, watertight seals and waterproof wiring.
- Cartridges are replaceable and interchangeable between bilge and aerator pumps.
- 12 volt.

Order No.	Mfg. No. / Description	Price
236326	(4640-7) 500 GPH Threaded 3/4"	\$34.98 R
2350082	(4643-7) 500 GPH Threaded 3/4" With 3/4" Seacock	\$36.98 H
236348	(4650-7) 800 GPH Threaded 3/4"	\$41.98 R
2350084	(4653-7) 800 GPH Threaded 3/4" With 3/4" Seacock	\$43.98 H
236350	(4660-7) 1,200 GPH Threaded 1-1/8"	\$52.98 H
236060	(4620-6) Replacement Motor Cartridge for 500 GPH	\$20.98 R
236079	(4622-6) Replacement Motor Cartridge for 800 GPH	\$30.98 H
236081	(4624-6) Replacement Motor Cartridge for 1,200 GPH	\$41.98 H
2350199	(3890-1) 90° Hose-to-Bar Connector - 3/4"-14 Threads	\$5.98 Q

Johnson Pump Cartridge Aerator Pumps



- Exclusive Anti-airlock feature.
- Quick replace motor cartridge.
- Crack resistant DuraPort fittings.
- 316 Stainless steel shaft.
- Tough thermoplastic housing.
- Extended life water cooled motor.
- Easy installation.
- 3 year warranty.
- Made in USA.
- 12 volt.

Order No.	Mfg. No. / Description	Price
470702	(28502) 500 GPH Straight	\$50.98 G
470714	(38502) 500 GPH 90°	\$53.98 Q
470699	(28703) 750 GPH Straight	\$62.98 Q
470719	(38702) 750 GPH 90°	\$60.98 Q
470721	(28103-00) 1,000 GPH Straight	\$66.98 Q
470722	(38103) 1,000 GPH 90°	\$73.98 Q
470743	(28571 PR) Spare Motor Cartridge for Ranger Style Pumps	\$63.98 LQ

Johnson Pump Transom Shims



- Transom shims for boats with severe angle to keep pump underwater to hinder airlock.

Order No.	Mfg. No. / Description	Price
470754	(71245)	\$10.98 G

Boater Sports Dual Mount Livewell Pump



- Cartridge design means simplified maintenance and unmatched safety when out on the water.
- Cartridge easily exchanges between bilge pumps or live well pumps in case of pump failure.
- High impact, fully sealed construction.

Order No.	Mfg. No. / Description	Price
1-57442	(57442) 800 GPH	\$33.95 H
1-57433	(57433) Replacement Cartridge	\$24.95 H

Boater Sports Dual Mount Livewell Pump



- 800 GPH thru-hull, submersible livewell pump with 3/4" hose outlet.
- Straight or angled mount.
- 30" marine-grade tinned lead wires.
- Salt or freshwater.
- 12 volt.

Order No.	Mfg. No. / Description	Price
1-57473	(57473)	\$27.95 H

Marpac Baitwell Pump



- Clean-up faster and easier than ever before!
- Quiet, efficient and compact.
- Hi capacity pump delivers 5.2 GPM for superior performance.
- Five chamber diaphragm pump that provides superior pressure.
- Rated continuous for up to 20 minutes.
- Strainer uses port connection for simple installation on inlet. (This makes it possible to remove entire unit for a thorough cleaning whenever it is most convenient.)
- Strainer features a transparent cover for simple inspection.
- Easy push-in connections include 3/4" ID threaded, straight and 90° hose barbs to make rigging simple.
- 12 volt.
- 3 year warranty. CE certified.

Order No.	Description	Price
7-0439	Baitwell Pump	\$248.98 G

Johnson Pump Baitwell Pumps



- Baitwell is a well thought out designed pump for pressurized water transfer to keep bait alive and active.
- 5 chamber pump head design for long life and quiet operation.
- 12 volt.
- Made in the USA.

Order No.	Mfg. No. / Description	Price
470734	(1013252103BW) 3.5 GPM 3/8" NPT/Hose 1/2"	\$162.98 Q
470736	(1013252107BW) 5.2 GPM 1/2" NPT/Hose 3/4"	\$238.98 Q

Johnson Pump Pro Series Livewell/Baitwell Pump



- Features heavy duty bronze bottom inlet, dual port capability, mega torque motor, double ball bearings, quiet running design, 1" NPT female intake.
- Built for the serious fisherman!
- 1,600 GPH.
- Connection: 1-1/8" and 1-1/4".
- 12 volt.

Order No.	Mfg. No. / Description	Price
470700	(16004B)	\$166.98 G

Johnson Pump Livewell Timer



- Livewell timer will turn on or cycle your aerator to increase the life of pump motor.
- On cycle pumps for 30 seconds, off cycle is variable from 0 to 5 1/2 minutes.
- Allows for continuous run for filling livewell.
- Keeps bait or fish alive without draining battery down.
- 3 wire installation easily replaces your on-off switch.
- 3/8" mounting hole for dashes up to 1" thick.
- Made in the USA.

Order No.	Mfg. No. / Description	Price
470746	(61125)	\$76.98 Q

Johnson Pump Mounting Bracket



- Gives opportunity to mount the pump on a wall.
- Suitable for Cartridge and Cartridge Duo.
- 90° side mount bracket.

Order No.	Mfg. No. / Description	Price
470744	(10605-00)	\$12.98 Q

Shurflo Pro Baitmaster II Livewell/Washdown Pump



- For continuous duty livewell or washdown applications in harsh environments.
- Seamless motor.
- Run dry capability. Continuous duty.
- Self-priming up to 6'.
- Thermally protected and ignition protected. Sealed switch.
- 4.0 GPM.
- 12 volt.
- Shut-off pressure: 45 PSI (3.1 bar).
- 2 year warranty.

Order No.	Mfg. No. / Description	Price
353184	(4648-153-E07)	\$298.98 G

- Fun & Flotation
- Anchor & Dock
- Safety
- Electronics
- Trolling Motors
- Lighting
- Electrical
- Topside Acc.
- Cockpit & Deck
- Instruments
- Steering, Controls
- Perform.
- Fuel System
- Engine & Parts
- Engine Care
- Propellers
- Seating & Pedestals
- Tops & Covers
- Pumps
- Cleaning & Care
- Paint & Paint Acc.
- Hardware, Fasteners
- Trailering
- Misc.
- Comm.

Jabco Fish Box Evacuation Pump



- Perfect for emptying a fish box after a day's fishing.
- 5 GPM output.
- Self-priming up to 10'.
- Capable of extensive dry running.
- 360° rotating head for flexible installation.
- Connections for 1-1/2" and 1" ID hose.
- Filterless design.
- 12 volt.

Order No.	Mfg. No. / Description	Price
414831	(50900-1000)	\$362.98 G

Attwood Tsunami RECIRQ Aerator Kit



- Recirculates livewell water to keep it cooler and rich in oxygen.
- This self-contained system feeds a separate aerator spray head and works even while you are underway and cannot use a thru-hull connection.
- Add this kit to any tank that already has freshwater fill system or use as a backup pump for a fail-safe system.
- Recirq Kit Includes: (1) 500 GPH Tsunami aerator pump with short inlet, threaded outlet, (1) 4125-1 aerator spray head, (1) 4232-1 stainless steel strainer, (1) 2 plastic hose clamps, (1) 3/4 diameter 23 poly hose, (1) Straight thread-to-barb connector.

Order No.	Mfg. No. / Description	Price
2350068	(4253-7) 500 GPH	\$50.98 H

Johnson Pump Cartridge Basspirator II Kit



- Includes: Aerator pump, 3/4" hose, clamps, aerating head, transom shims and overflow drain with hose and additional wire.
- Made in the USA.
- 12 volt.

Order No.	Mfg. No. / Description	Price
470690	(34014)	\$119.98 LQ

Johnson Pump Ice Chest Aerator Kit



- Convert any good sized chest into your own portable live bait tank.
- Kit includes a sturdy First Mate pump, hose, spray bar, press-on clamp, battery clamps and clear cut instructions.
- Made in the USA.

Order No.	Mfg. No. / Description	Price
470752	(24052) 400 GPH	\$43.98 G

Engel Live Bait Coolers



- Molded polystyrene insulation helps protect bait in hot and cold conditions.
- Durable high impact plastic base and lid won't absorb odors and is easy to clean.
- Watertight EVA gasket in lid prevents splashing during transport.
- Corrosion resistant self-stopping hinges.
- Stainless steel latches and screws.
- Easy to carry using integrated handle in lid or shoulder strap (included).
- Remove the pump and hose and easily convert to cooler.
- Air pump features: 2-speed pump maximizes aeration and battery life, water-resistant housing protects motor and suppresses noise, stainless steel clip attaches pump to cooler, flexible silicone hose and weighted air stone for lively bubbling action.
- Note: Cooler can not be watertight when air hose is being used. By removing the air hose and utilizing the air hose plug (attached on the inside of cooler) you can make the cooler watertight.

Order No.	Mfg. No. / Description	Price
481070	(ENGLBC13) 13 Quart Dimensions: 15" x 10" x 11"	\$61.98 E
481072	(ENGLBC19) 19 Quart Dimensions: 16.6" x 11" x 13"	\$65.98 E
481074	(ENGLBC30) 30 Quart Dimensions: 19.5" x 12.5" x 14.5"	\$69.98 E

Rule Portable Aerator Kit



- Aerates from 5 to 30 gallons of water.
- Attaches easily with suction cups to any non-porous surface.
- 9" long spray tube can be custom cut to fit into any container.
- A fully adjustable spray head increases or reduces flow of water.
- Foam filtration system keeps water sparkling clean.
- The kit also includes battery clips for easy attachment to your 12 volt power source.
- 12 volt.



Order No.	Mfg. No. / Description	Price
581896	(202K) 460 GPH	\$51.98 F

Rule Gentle-Flow™ Oxygenator



- Produces millions of micro-fine bubbles with patented infusor technology.
- Directional discharge.
- Flexible installations for most custom tanks.
- Flow control with "Air Control" center.
- Port: 3/4" hose barb.
- Ideal for 25 lbs. of bait.
- Kit comes complete with a pump, directional discharge, intake strainer, hose and intake valve.



Order No.	Mfg. No. / Description	Price
581865	(255) 12 volt	\$120.98 F

- Fun & Flotation
- Anchor & Dock
- Safety
- Electronics
- Trolling Motors
- Lighting
- Electrical
- Topside Acc.
- Cockpit & Deck
- Instruments
- Steering, Controls
- Perform.
- Fuel System
- Engine & Parts
- Engine Care
- Propellers
- Seating & Pedestals
- Tops & Covers
- Pumps
- Cleaning & Care
- Paint & Paint Acc.
- Hardware, Fasteners
- Trailer
- Misc.
- Comm.

T-H Marine Automatic Aerator Control - 10 amp



- Provides a source of oxygen-rich water to your livewell automatically.
- This unit features a solid-state timer with adjustable off times to adjust to varying conditions.
- Easily adaptable to existing systems.
- Requires a 3" diameter round hole or a 2-1/2" square hole for mounting.
- Front panel is 3-1/4" x 3-1/4" and requires only 3" behind panel.
- Fully potted to be waterproof.

Order No.	Mfg. No. / Description	Price
641678	(AAC-1-DP)	\$83.98 H

T-H Marine Remote Drain Controls



- Eliminates the problem of plugging and unplugging drain while fishing.
- Drain livewell/baitwell from the cockpit.
- Stainless steel vinyl jacket cable system, 8-1/2' long.
- Fits 3/4" hose.

Order No.	Mfg. No. / Description	Price
641329	(RDCF-1-DP) Flush Mount Rotary Parallel Hook-Up	\$67.98 H
641438	(RDV-2-DP) Replacement Valve Only	\$32.98 H
6400103	(CAF-1-DP) Cable Assy. for Remote Drain, Push/Pull Type	\$36.98 H

Flow-Rite Controls V1 Two-Position Shut Off Valve

- Remote drain control for any boat's livewell, baitwell or cooler.
- Provides OPEN/CLOSED modes.
- Eliminates the need for drain plugs and standpipes.
- A short 60° cable throw provides more support, strength, and smoothness than long 90° throws used with conventional valves.
- Features dual seals for positive shut-off in the "CLOSED" position and a straight unrestricted flow path in the "OPEN" position.
- This valve is non-directional.



Order No.	Mfg. No. / Description	Price
2000630	(MPV-1-FN01)	\$40.98 G

Flow-Rite Controls Flappers



- 1-3/8" x 7/8".

Order No.	Mfg. No. / Description	Price
2000624	(MA-001) Regular Flapper without Button	\$2.00 G
2000625	(MA-002) Button Flapper with Button	\$4.00 G

T-H Marine EZ-Pump™ Advanced Water Pickups



- Provides water to aerator pump pickup while underway.
- Mounts over pump intake.
- Prevents livewell system air lock.
- Screen and pick-up all in one.

Order No.	Mfg. No. / Description	Price
247617	(EZ-BLK-1-DP) Length 4-3/4" Intake: 1" to 3-1/2" Black	\$19.98 Q
247619	(EZ-WHT-1-DP) Length 4-3/4" Intake: 1" to 3-1/2" White	\$19.98 Q

T-H Marine Pro-Air System - Livewell Aeration



- The Pro-Air System air pump has advanced design features that are engineered under rigid quality control conditions to insure long lasting dependable oxygen rich air source to your livewell or baitwell.
- Easy mount for fixed or portable tanks.
- Dual outlets can aerate two livewells at once.
- Comes complete with pump, two air stone mounts, two air stones, switch panel and 20 feet of air line tubing.
- For 12 volt applications.

Order No.	Mfg. No. / Description	Price
641503	(PAS-1-DP)	\$88.98 R
641504	(PAP-1-DP) Replacement Pump Only	\$86.98 R

Flow-Rite Controls V2 Two-Position Automatic Valve



- Ideally used in bass boats, flats boats, and other low profile boats for automatic drain control and livewell management.
- Accepts mounting of one standard aerator pump for both filling and recirculation.
- Reversible check valve that allows a single pump to not only perform the basic livewell functions necessary to keep the catch alive, but does it in a passive or automatic manner.
- By mounting the pump to the valve body, the operator only has to decide whether he wants his livewell functioning or empty.
- When the first fish is caught, place the valve in the "AUTO" position and turn on the pump. When the boat is off plane the pump will recirculate and aerate the livewell water and simultaneously blend in a portion of fresh lake water. Used livewell water is expelled out the overflow as fresh water enters to prevent any ammonia build up.

V2 TWO-POSITION AUTOMATIC VALVE

- Provides EMPTY/AUTO modes.

Order No.	Mfg. No. / Description	Price
2000632	(MPV-02-FN01) Cable Attachment: Livewell/Front Side, Barbed	\$48.98 G

V3 THREE-POSITION AUTOMATIC VALVE

- Provides RECIRC/EMPTY/AUTO modes.
- Includes closed recirculation mode which allows addition of optional pump-out system.

Order No.	Mfg. No. / Description	Price
2000636	(MPV-03-FN01) Cable Attachment: Livewell/Front Side, Barbed	\$50.98 G

- Fun & Flotation
- Anchor & Dock
- Safety
- Electronics
- Trolling Motors
- Lighting
- Electrical
- Topside Acc.
- Cockpit & Deck
- Instruments
- Steering, Controls
- Perform.
- Fuel System
- Engine & Parts
- Engine Care
- Propellers
- Seating & Pedestals
- Tops & Covers
- Pumps**
- Cleaning & Care
- Paint & Paint Acc.
- Hardware, Fasteners
- Trailering
- Misc.
- Comm.

T-H Marine Aerator Spray Heads



641553



641540

- Sprays aerated water into livewells.
- Keeps catch and bait fish alive.
- Hose ID 3/4".
- Mounting hole diameter 1-1/16".

FIXED FLANGE WITH ON-OFF VALVE

Order No.	Mfg. No. / Description	Price
641540	(AHV-1DP) Maximum Wall Thick 3/8" Black Straight	\$11.98 H
641553	(AHV-92-DP) Maximum Wall Thick 5/8" White 90°	\$7.98 Q

SCREW ON VALVE WITH ON-OFF VALVE

Order No.	Mfg. No. / Description	Price
640108	(AHV-90DP) Maximum Wall Thick 3/4" Black 90°	\$11.98 H

Johnson Pump Aerating Heads



470827



470815

OVERALL LENGTH 13-3/4" THRU-HULL. ONE SHUT OFF VALVE

Order No.	Mfg. No. / Description	Price
470827	(90191-00)	\$26.98 Q

OVERALL LENGTH 10-1/2", 3/4" BARB. ONE SHUT OFF VALVE

Order No.	Mfg. No. / Description	Price
470815	(90681-00) With Bracket	\$24.98 Q

T-H Marine Livewell Overflow Drain Tubes - Push-In Tubes



- Tough, flexible vinyl plastic end with a standpipe of white PVC tubing.
- To use simply insert vinyl end into the opening of thru-hull fitting.
- To drain livewell or baitwell, simply remove.

Order No.	Mfg. No. / Description	Price
641387	(ODT-1-DP) Fits 1-1/8" Drain Straight Length 12"	\$10.98 H
641388	(ODT-190-DP) Fits 1-1/8" Drain 90° Length 12"	\$11.98 H
641399	(ODT-2-DP) Fits 1-1/2" Drain Straight Length 18"	\$28.98 H
641386	(ODTS-1-DP) Screen for ODT-1 and ODT-190	\$3.24 H
641390	(ODTS-2-DP) Screen for ODT-2	\$6.98 H

T-H Marine Directional Aerator Heads



- Great for saltwater baitwells.
- Creates circular current.
- Comes with 90° fitting.
- Screw-in head.
- Maximum wall thickness 5/8".

Order No.	Mfg. No. / Description	Price
641591	(DAH1K-118-DP) Fits 1-1/8" Hose	\$10.98 H
641589	(DAH1K-750-DP) Fits 3/4" Hose	\$10.98 H

T-H Marine Remote Diverter Valve



- Functions: Baitwell/washdown.
- Control two systems from cockpit.
- Diverts water to two systems from one pump.
- Fits 3/4" hose.

Order No.	Mfg. No. / Description	Price
641489	(DVO-1-DP) Diverter Valve Only	\$46.98 LQ

Attwood Adjustable Spray Aerator Heads



2350201



2350200

- Use on livewells that have built-in overflows or recirculating systems.
- Mounts on side of tank.
- 90° fitting for installation in tight spaces.
- Rotating head with O-ring adjusts and maintains flow setting.
- Removable head has an interference-fit thread design that will not allow it to vibrate or blow out.
- Polypropylene construction.
- Can be installed on tanks with up to 5/8" wall thickness.
- Hose ID 3/4".

Order No.	Mfg. No. / Description	Price
2350200	(4123-1) With Male Conn. for Flow-Rite Qwick-Lock Coupler	\$3.13 H
2350201	(4125-1)	\$9.98 H

T-H Marine Bait Tank and Plumbing Kit



- This kit includes professionally designed systems for aeration, directional flow, overflow drain and complete drain accessories.
- The kit contains the following products:
 - 641388 (ODT-190) 90° overflow drain tube
 - (TH-1202) 1-1/8" thru-hull for overflow control, drain plugging and well draining
 - 641540 (AHV-1) valved aeration head for pumping in fresh water
 - (DAH-90) directional aerator head for current creation
 - 641375 (TEE-3/4) tee to connect both aerator heads to aerator pump

Order No.	Mfg. No. / Description	Price
236388	(BWK-2-DP)	\$33.98

- Fun & Flotation
- Anchor & Dock
- Safety
- Electronics
- Trolling Motors
- Lighting
- Electrical
- Topside Acc.
- Cockpit & Deck
- Instruments
- Steering, Controls
- Perform.
- Fuel System
- Engine & Parts
- Engine Care
- Propellers
- Seating & Pedestals
- Tops & Covers
- Pumps
- Cleaning & Care
- Paint & Paint Acc.
- Hardware, Fasteners
- Trailer
- Misc.
- Comm.

T-H Marine Push In Plugs for Drains



- These push plugs are used to stop water flow through drains or overflows from baitwell or livewell.
- Plugs are a great compliment to T-H Marine overflow drain tubes.
- Injection molded of marine grade black PVC.
- Features a pull ring for easy removal.
- It also has a double seal ring to assure positive sealing.

Order No.	Mfg. No. / Description	Price
641426	(PP-150-DP) For 1-1/2" Thru-Hulls	\$11.98 H
641507	(PP-118-DP) For 1-1/8" to 1-1/4" Thru-Hulls	\$7.98 H

Boater Sports Stainless Steel Wire Mesh Strainer



- This screw-on strainers are made from formed stainless steel wire mesh cloth and then molded into a PVC base with internal threads.
- Black base with 3/4" female threads.
- Packaged for display.

Order No.	Mfg. No. / Description	Price
1-57075	(57075)	\$6.95 H

T-H Marine Baitwell Filter



- This baitwell filter installs with the overflow fitting on baitwells to prevent bait fish being lost.
- Black injection molded base.
- Designed to fit either 1-1/8" or 1-1/2" diameter thru-hull fittings.

Order No.	Mfg. No. / Description	Price
641680	(BWF-1-DP)	\$7.98 H

T-H Marine Aerator Filter



- An externally installed filter for aeration systems.
- Made of black poly material.
- It prevents foreign matter from clogging pump.
- Installs with three screws over intake for aerator pumps.

Order No.	Mfg. No. / Description	Price
641604	(AF-1-DP)	\$5.98 H

T-H Marine Aerator Stainless Steel Wire Mesh Strainers



- Designed to provide effective, dependable protection against trash or fish scales which could clog drains in bait wells or pump impellers in aeration systems.
- Made from formed stainless steel wire mesh cloth and then molded into a black PVC base with internal threads this unit is non-corrosive, functional and looks extremely good installed on any boat.

USED ON ANY AERATOR PUMP INTAKE

- Simply screws onto threaded pump intake in livewell or on exterior of boat.
- Thread: 3/4" - 14.

Order No.	Mfg. No. / Description	Price
641642	(AS-1-DP)	\$11.98 H

USED AS A STRAINER ON LIVEWELL DRAINS

- Screws onto thru-hull fitting.
- Thread: 1" - 8.

Order No.	Mfg. No. / Description	Price
640088	(AS-2DP)	\$11.98 H

T-H Marine Thru-Hull Strainer Mount



- Designed to enable a 3/4" thru-hull passage thru a transom or livewell wall and to attach an aerator screen on the other side.
- This fitting allows the screen to mount flush against the wall with no extra nut to secure the fitting.
- Includes: Thru-hull (THSM-1) and **641642** (AS-1) wire mesh strainer.

Order No.	Mfg. No. / Description	Price
641869	(THSM-1KIT-DP)	\$14.98 H

T-H Marine Max-Air™ Livewell Venturi Aerator



- The venturi system draws fresh air from outside the livewell and injects tiny air bubbles into the water flowing into the livewell.
- With the aerated water entering the well at a lower level than with traditional spray heads, the entire well is more thoroughly aerated.
- The reduced restriction of this fitting allows more water to flow from the pump than traditional spray heads.
- The faceplate inlet can be mounted anywhere above the waterline.
- Includes: Venturi fitting with air intake face plate and 6' speedo tubing.

Order No.	Mfg. No. / Description	Price
641527	(MAV-2KT-DP)	\$19.98 H

- Fun & Flotation
- Anchor & Dock
- Safety
- Electronics
- Trolling Motors
- Lighting
- Electrical
- Topside Acc.
- Cockpit & Deck
- Instruments
- Steering, Controls
- Perform.
- Fuel System
- Engine & Parts
- Engine Care
- Propellers
- Seating & Pedestals
- Tops & Covers
- Pumps
- Cleaning & Care
- Paint & Paint Acc.
- Hardware, Fasteners
- Trailering
- Misc.
- Comm.

T-H Marine G-Juice Livewell Treatment Solution



- A single phase, full functional water conditioner for use in fresh and salt water.
- Conditions water entering the livewell, bait tanks, minnow buckets and in fish transport situations.
- Non-toxic to humans, pets and aquatic life.
- Removes Nitrites, Ammonia, Chlorine,
- Adds Essential Electrolytes Chloramines and Heavy Metals.
- Replaces skin slime and stops bleeding.

Fun & Flotation

Anchor & Dock

Safety

Electronics

Trolling Motors

Lighting

Electrical

Topside Acc.

Cockpit & Deck

Instruments

Steering, Controls

Perform.

Fuel System

Engine & Parts

Engine Care

Propellers

Seating & Pedestals

Tops & Covers

Pumps

Cleaning & Care

Paint & Paint Acc.

Hardware, Fasteners

Trailer

Misc.

Comm.

Order No.	Mfg. No. / Description	Price
640964	(U216-FW) 16 oz.	\$18.98 Q

T-H Marine G-Force Cull System



- Quick and accurate tournament culling system.
- Fast balance beam culling.
- Consists of an all aluminum balance beam & handle and (6) vinyl covered culling lines with 2-1/2" color coded buoys with stainless steel hooks.
- Allows you to handle your fish only once.

Order No.	Mfg. No. / Description	Price
642653	(GFC-1-DP)	\$45.98 H